

STG Series Pockels Cell (EO Q-switch, Electro-optic Q-switch)



A Pockels cell alters the polarization state of light passing through it when an applied voltage induces birefringence changes in an electro-optic crystal such as KD*P and BBO. When used in conjunction with polarizers, these cells can function as optical switches, or laser Q-switches. Frequently, Q-switches are employed in laser cavities for the purpose of shortening the output pulse, resulting in a light beam with enhanced peak intensity. In order to provide the device best suited to your purpose, we offer the industry standard ST-QX series, economical STG-IMPACT cells, BBO-based STG-LightGate, and large-aperture STG-TX Pockels cell lines. High-speed electronic drivers properly matched to the cell produce the best results for short pulse applications.

You can operate the cell with either a pull-up voltage or a pull-down voltage. Changing the polarity will only change the direction of the phase rotation. You should not, however, operate the cell with a constant applied voltage potential between the terminals, or a duty cycle greater than ~ 2%.

List of STG Series Pockels Cells

Product Series	Wavelength	Voltage Contrast Ratio	Active Aperture	Optical Material
STG-Chiron BBO	0.2-1.65 μm	> 500 1 @ 1064 nm	3.25 mm	BBO
CdTe STG-IRX Mid-IR	5-12 μm	>500 1 @ 10.6 μm	3 - 7,4 x10 mm	CdTe
STG-IMPACT	300-1100 nm	>2000 1 @ 1064 nm	8 - 13 mm	KD*P
STG-QX1014A Short Path Length	300-1100 nm	>450 1	N/A	KD*P
STG-QX Series	300-1200 nm	varies	9.25 - 19.5 mm	KD*P
STG-TX Series	300-1300 nm	varies	19.5 - 99 mm	KD*P
STG-LightGate Series BBO	300- 600 nm	>1000 1 @ 1064 nm	2.6 - 7 mm	BBO

1. STG-IMPACT Series EO Q-switches

From the world leader in nonlinear materials and electro-optic devices comes the ideal Pockels cell for OEM applications, the STG-IMPACT. Once again, we set the industry standard - and at an exceptional price. In general, it operates below 1kHz.

The STG-IMPACT employs the finest strain-free, highly deuterated KD*P available. Ceramic apertures ensure robust performance in demanding applications. Ultra-high-damage threshold Sol Gel and dielectric AR coatings are offered for a variety of laser wavelengths. The standard pin-type connectors (superior for high-voltage applications) provide quick connections and simplified design and assembly. Conventional threaded connectors are available as an option. The STG-IMPACT is back-filled with dry nitrogen.



Applications:

- OEM laser systems
- Medical/cosmetic lasers
- Versatile R&D laser platforms
- Military & aerospace laser systems

FEATURES	BENEFITS
CCI Quality - economically priced	Exceptional value
Finest strain-free KD*P	High contrast ratio

	High damage threshold Low 1/2 wave voltage
Single pass optical transmission	>98%
Space efficient	Ideal for compact lasers
Ceramic apertures	Clean and highly damage-resistant
High contrast ratio	Exceptional hold-off
Quick electrical connectors	Efficient/reliable installation
Ultra-flat crystals	Excellent beam propagation

Typical Specification

Electro-optical @ 1064nm				
1/4 Wave Voltage: 3.3 kV				
Transmitted Wave Front Error : <1/8 Wave				
ICR>2000:1				
VCR>1500:1				
Capacitance: 6 pF				
Sol Gel Damage Threshold @ 1064nm, 10ns pulse: 40J/cm ²				
Housing Dimensions	STG-IMPACT 8	STG-IMPACT 9	STG-IMPACT 10	STG-IMPACT 13
Aperture	8 mm	9.25mm	10 mm	13 mm
Length	25 mm	37mm	39 mm	45 mm
Diameter	19 mm	25.3mm	25.35 mm	25.35 mm

Remark:

- STG-Impact 8 standard wavelength: 1064nm & 800nm
- STG-Impact 10/13 standard wavelength: 1064nm & 755nm
- The 1/4 wave voltage for any of our KD*P cells, @ 800nm, will be ~2.5KV, +/- 10%

2. STG-QX Series EO Q-switches

The STG-QX series sets the standard for KD*P electro-optic Q-switches. These devices provide reliable, stable performance for a diverse range of laser applications.

We offer a unique rebuild program that extends the STG-QX lifetime. All rebuilt units are upgraded with the latest product improvements and are returned with a new one-year warranty.



The standard configuration employs a broad band, high damage threshold Sol Gel AR coating for improved durability and performance. The STG-QX series is also available with index matching fluid and a choice of end caps. All units are tested for optic and electric function and are supplied with a QA inspection report.

Features

- Industry-proven performance
- Dry or fluid-filled
- Highest (99.9% KD*P) deuteration levels in industry
- Adhesive/Epoxy-free assembly
- Premium UV-grade fused silica windows
- Apertures from 9.25mm diameter up to 19.5mm diameter
- Lowest absorption in industry
- High-reliability
- Economical upgrade/rebuild program
- Highest optical damage thresholds
- Accessible technical support
- Standard performance documentation

- One-year limited warranty
- Operation up to 10kHz (special order)

Specifications

Typical Specification 99% KD*P	STG-QX1020	STG-QX1320	STG-QX1630	STG-QX2035
Physical				
Hard aperture diameter	9.25 mm	12.3 mm	15.1 mm	19.5 mm
Single Pass Insertion Loss	<1.4%	<1.4%	<1.8%	<2.0%
Voltage Contrast Ratio				
(Cross polarizers)	5000:1	4000:1	3500:1	3000:1
(Parallel polarizers)	2500:1	1500:1	1800:1	1000:1
DC Quarter wave voltage @1064nm	3.5 kV	3.5 kV	3.5 kV	3.5 kV
Single Pass Distortion @ 633nm	< $\lambda/8$	< $\lambda/8$	< $\lambda/8$	< $\lambda/6$
Electrical				
Capacitance @ 1 kHz	5pF	7pF	9pF	13pF
10-90% Rise time (50 Ω line)	0.8 ns	1.1 ns	1.1 ns	1.5 ns
Outline dimensions				
Diameter	34.8mm	39.7mm	41.3mm	46.2mm
Length	55.7mm	58.6mm	71.0mm	83.9mm

STG-QX1014A Short Path Length Pockels Cell

The newest model in the industry standard STG-QX series Pockels cell product line, the STG-QX1014A employs short path length components to reduce nonlinear self-focusing in higher peak power applications and temporal pulse broadening in femtosecond applications.

Attenuated crystal mounting minimizes acoustic artifacts when operating at repetition rates of up to 10kHz, or higher, depending upon the application. Employing internally sourced high-quality, low strain KD*P, the STG-QX1014A benefits from decades of electro-optic design and manufacturing experience.

The attenuation (damping) modification minimizes undesirable acoustic ringing effects, thereby permitting effective operation up to 10kHz. A variety of AR coating options are available, including our proprietary broadband 700-1000nm AR coating – ideal for minimizing round trip losses in Ti:Sapphire regenerative amplifiers.

Key Features

- Short path length for operation up to 10kHz
- Customized AR coatings including broadband AR for Ti:Sapphire applications, choice of optional wavelengths, ceramic hard clear apertures, low VOC construction materials and high-quality KD*P

Key Benefits

- Reduced B-integral for high-damage threshold
- High throughput (low losses)

Applications

- Ultrafast regenerative amplifiers for spectroscopy; material processing; optical parametric amplification; femtosecond lasers for life sciences (e.g. LASIK) and material processing (e.g. photolithography mask repair)
- Scientific research



Specifications

- Hard aperture diameter: 8mm
- Intrinsic contrast ratio (ICR) @ 633 nm: >1200:1
- Voltage contrast ratio (VCR) @ 633 nm: >450:1
- Optical transmission @ coating wavelength: >98%
- DC half-wave voltage @ 633 nm: $\leq 3.8\text{kV}$
- Transmitted wavefront error TWE (single pass distortion) @ 633 nm: $\leq \lambda / 8$
- Outline dimensions: Dia.34.8mm, Length 51.6mm

3. STG-LightGate Series BBO Pockels Cell

STG-LightGate BBO Pockels cells are the preferred alternative to KD*P Pockels cells for high-average power and high repetition rate applications. The STG-LightGate series BBO Pockels cell employs dual crystal geometry to minimize drive voltage (~3.4kV quarter-wave voltage @ 1064nm for 4mm aperture LightGate 4). BBO is transparent from approximately 0.2 to 2.1mm and is not subject to tracking degradation. It also shows low piezoelectric ringing, which is useful for repetition rates of hundreds of kilohertz. STG-LightGate Pockels cells are useful for regenerative amplifiers and in high pulse repetition rate micro-machining lasers and high-average power lasers for material processing and metal annealing. We also offer special single crystal cells, extra-long, reduced voltage cells and cells attenuated for ultra-low ringing, for special applications.

Features: .

- Solid state – no index matching fluid
- High repetition rate as high as 600kHz
- Low acoustic noise
- Damage resistant ceramic apertures
- High average power applications
- Compact design
- Q-switch and regen-amp applications



Applications

- OEM and replacement laser systems such as machining, marking, via drilling, ophthalmology, Q-switching and regenerative amplifiers and research.
- Military

Typical Specification	STG-LG2.6	STG-LG3	STG-LG4	STG-LG5	STG-LG7
Physical					
Hard aperture diameter	2.6 mm	3.25 mm	4mm	5.5 mm	7mm
Single pass insertion loss@1064nm	<154%	<1.5%	<1.5%	<1.5%	<1.5%
Intrinsic contrast ratio (ICR)@1064nm	>1000:1	>1000:1	>1000:1	>1000:1	>1000:1
Voltage contrast ratio (VCR)@1064	>500:1	>500:1	>500:1	>500:1	>500:1
Single pass wavefront distortion@1064nm	$< \lambda / 6$	$< \lambda / 6$	$< \lambda / 6$	$< \lambda / 6$	$< \lambda / 6$
LIDT, 10Hz@1064nm, 10ns, ~1mm dia.	10J/cm ²	10J/cm ²	10J/cm ²	10J/cm ²	10J/cm ²
Single Pass Distortion @ 633nm	$< \lambda / 8$	$< \lambda / 8$	$< \lambda / 8$	$< \lambda / 6$	
Electrical					
Capacitance @ 1 kHz	~4pF	~4pF	~4pF	~4pF	~4pF
DC quarter wave voltage @1064nm	1.9 kV	2.3 kV	2.9 kV	3.8 kV	4.7kV
10-90% rise time (50Ω line)	~1ns	~1ns	~1ns	~1ns	~1ns
Duty cycle in 1s (applied voltage time/total time)	<5%	<5%	<5%	<5%	<5%
Outline dimensions					
Diameter	25.3mm	25.3mm	25.3mm	25.3mm	25.3mm
Length	78mm	78mm	78mm	78mm	78mm

4. STG-CHIRON BBO Pockels Cell

STG-Chiron BBO Pockels cell raises the bar for high repetition rate and high average power laser applications. The STG-Chiron BBO Pockels cell design builds on the dual crystal geometry successfully used to minimize drive voltage (~2.3 kV quarter-wave voltage @1064 nm for the STG-Chiron). BBO Pockels cells operate from approximately 0.2 to 1.65 μm and are not subject to tracking degradation. Due to the low piezoelectric coupling coefficients of BBO, the Chiron 3 functions at repetition rates up to 1 MHz. STG-Chiron Pockels cells work in regenerative amplifiers, high pulse repetition rate micro-machining lasers, and high-average power lasers for material processing and metal annealing.



Key Features

- High pulse rate operation to 1 MHz
- Solid state – no index matching fluid
- Low acoustic noise
- Damage resistant ceramic apertures
- Compact design
- High-reliability
- Operation at high average power

Key Benefits

- Ideal for high average power systems
- Low absorption leading to reduced thermal lensing/thermal depolarization
- Exceptional high repetition rate performance
- Excellent, accessible technical support

Applications

- Military
- OEM and replacement laser systems for machining, marking, via drilling; ophthalmology; Q-switching and regenerative amplifiers; research

Specifications:

- Hard aperture diameter: 3.25 mm
- Single pass insertion loss @ 1064 nm: < 1.5%
- Intrinsic contrast ratio (ICR) @ 1064 nm: > 1000:1
- Voltage contrast ratio (VCR) @ 1064 nm (parallel polarizers): > 500:1
- Single pass wavefront distortion @ 1064 nm: < $\lambda / 6$
- LIDT1, 10 Hz @1064 nm, 10 ns, ~1 mm diameter: 10 J/cm²
- Capacitance (DC): ~4 pF
- DC half wave voltage @ 1064 nm: 4.3 to 4.9 kV
- Temperature range exposure to simulate storage and shipping conditions:-25°C to 50°C
- 10-90% rise time (theoretical) into 50 Ω line:~1 ns
- Duty cycle in 1 s (applied voltage time / total time): <5%
- Dimensions: dia. 25.3mm length 57.7mm

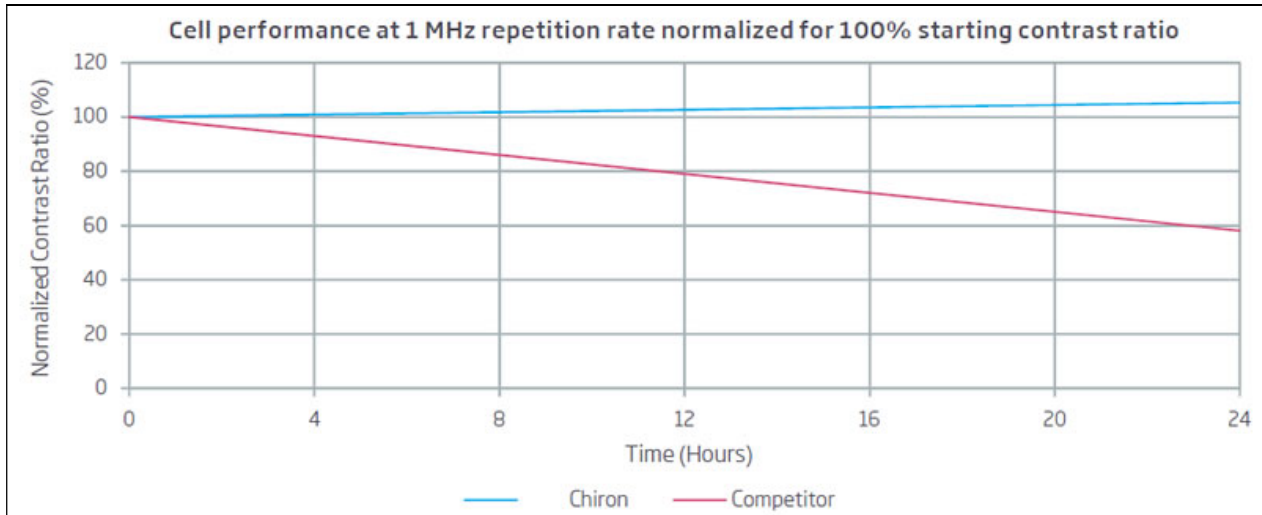

5. STG-TX Series KD*P Pockels Cells

STG-TX series KD*P Pockels cells are the most advanced large aperture optical isolators commercially available and are proven performers in high power applications. We are the leading producer of Pockels cells for the development of laser induced nuclear fusion and sub-micron microlithography. Nearly 300 units are in use worldwide; more than twice the total from all other manufacturers combined. We have incorporated state-of-the-art features, such as specially modified cylindrical-ring electrode geometries for optimum aperture extinction and transmission uniformity and minimum optical path length. Series STG-TX cells also feature axially adjustable windows for sub-millimeter control of window/crystal spacing and 224 TPI differential screws for arc-second adjustment of windows parallelism or net wedge. These units typically have a lifetime of many years and can often be rebuilt for a fraction of the cost of a new unit. Each unit comes with detailed 2-page/4-photo test documentation for quality assurance. We install premium 50 ohm GHV series electrical receptacles on series STG-TX cells because of their 20 kVDC and 1 GHz mil-spec ratings (used with RG-8 A/U or RG-213/U coaxial cable). We stock GHV bulkhead receptacles as well as cable-end plugs.

Features

- Axially adjustable windows for sub-millimeter control of window/crystal spacing
- 224 TPI differential screws for arc-second adjustment of input/output windows parallelism
- Double fill/drain ports
- Individually accessible crystal faces for convenient inspection or cleaning
- 50 C transmission line drive configuration is standard.
- Precision milled and epoxy-free
- A range of apertures available



Benefits

- Expanded beam allows for reduced intensity

Applications

- Q-switching and optical isolators in pettawatt/terawatt lasers
- Optical isolation and low frequency modulation of high power visible to NIR laser beams

Typical Specifications	STG-TX2042	STG-TX2650	STG-TX3460	STG-TX5065	STG-TX7595	STG-TX100D
PHYSICAL						
L x H x W (mm) ¹	85x80x85	97x87x92	102x95x103	115x111x119	151x136x144	157x 161x169
Hard aperture	19.5 mm	25.5 mm	33.5 mm	49.5 mm	73.5 mm	99.0 mm
Weight	1.1 kg	1.4 kg	1.9 kg	2.7 kg	5.4 kg	7.5 kg

Crystal deuteration ²	95%	95%	95%	95%	95%	95%
OPTICAL (1064nm)						
Single pass insertion loss	3.5%	4%	5%	5%	6.5%	7%
Voltage contrast ratio						
Crossed polarizers	8000:1	8000:1	6000:1	3000:1	800:1	200:1
Parallel polarizers	3000:1	2500:1	1500:1	500:1	300:1	100:1
Maximum residual birefringence (typically < 1% of aperture)	< 10 nm	< 12 nm	< 18 nm	< 20 nm	< 40 nm	< 80 nm
DC halfwave voltage	6.4 kV	6.4 kV	6.7 kV	6.9 kV	7.3 kV	7.7 kV
Single pass distortion	$\lambda/20$	$\lambda/20$	$\lambda/20$	$\lambda/20$	$\lambda/20$	$\lambda/20$
ELECTRICAL						
Capacitance @ 1 kHz	23 pF	27 pF	32 pF	56 pF	86 pF	115 pF
10-90% risetime	1 nsec	<2 nsec	2 nsec	3 nsec	5 nsec	7 nsec

1 L=housing length along optic axis direction; W=width between electrical terminals; H=height
 2 99% deuterated KD*P and UV-grade KDP also available in certain sizes.

6. STG-IRX Series CdTe Pockels Cell

Initially designed to address the Q-switched CO₂ laser market at 10.6 μ m, the cadmium telluride - based STG-IRX Q-switch may be configured to operate from 3-12 μ m. Its' high electro-optic coefficient and non-hygroscopic nature makes CdTe well-suited for this purpose. Through more than 30 years of electro-optic device design experience, we provide IRX Pockels cells with application-specific AR coatings or Brewster-cut ends, in apertures ranging from 3mm-10mm. The IRX Pockels cells are able to address applications beyond the spectral range of traditional oxide Pockels cells.



Features

- High electro-optic coefficient CdTe crystal
- Available with apertures ranging from 3-10 mm AR coated or Brewster-cut crystals available
- Environmentally isolated EO crystal
- Customized versions available
- Active cooling available (patent pending)
- Operation from 3 μ m-12 μ m up to 100 kHz
- Patent pending environmental control and high power water cooled option
- Non-hygroscopic material
- Low optical absorption

Benefits

- High contrast ratio
- Operation over wide spectral range

Applications

- CO₂ laser Q-switching
- IR pulse picking

Typical specifications	STG-IRX3	STG-IRX4	STG-IRX5	STG-IRX7	STG-IRX9
Aperture diameters 1	3 mm	4 mm	5 mm	7 mm	9 mm
Optical transmission	>98% @ 10.6 μ m with 10.6 μ m coatings				
Intrinsic contrast ratio (ICR) @ 10.6 μ m	>500:1				
Voltage contrast ratio (VCR) @ 10.6 μ m	>500:1				
Single pass wavefront distortion @ 10.6 μ m	< $\lambda/4$				
Spectral range of operation	Must specify wavelength or band within 5-12 μ m range				
Optical transmission	>98% @ 10.6 μ m with 10.6 μ m coatings				
LIDT 2	2.3 J/cm ² , 1 mm diameter, 2.94 μ m, 2 Hz, 100 ns				
DC quarter-wave voltage (\pm 6%) @ 10.6 μ m	~4 kV	~5 kV	~6 kV	~7 kV	~9 kV
Capacitance (DC)	~ 6 pF				

10-90% rise time (theoretical) into 50 Ω line	~0.3 ns
Duty cycle in 1 s (applied voltage time/total time)	< 10%
Dimensions	Dia 34.9mm, Length 92.7mm

1 Custom aperture sizes available

2 Recommended operation at 1/10 this fluence for increased longevity. LIDT will vary with wavelength and beam parameters.

RTP Electro-optic Q-Switch

RTP (Rubidium Titanyl Phosphate) is a robust electro - optic crystal suitable for a wide variety of applications (such as Q - Switches, Amplitude & Phase Modulators, Pulse Pickers, etc.) and operation in industrial, medical, and defense products. The crystal is transparent at most common visible and near infrared laser wavelengths. It performs well over a wide temperature range (from - 500C to +700C) and at high repetition rates. RTP based Q - switch devices are offered in matched pair configurations, in a temperature compensating design. When used for applications such as Q-switches and Amplitude Modulators, the crystals are mounted such that the input beam is polarized along the diagonal of the face. Our Q-switch is built using 2 RTP (Rubidium Titanyl Phosphate) elements in a temperature compensating design. The unique properties of RTP, including high electrical resistivity ($\sim 10^{12} \Omega\text{-cm}$) and a high damage threshold, result in a Q-switch with excellent properties.



Advantages:

- High Damage Threshold: No Piezoelectric Ringing
- Low Insertion Loss: Thermal Compensating Design
- Non-hygroscopic

Specifications:

- Transmission at 1064 nm: > 98.5 %
- Half Wave Voltage at 1064 nm, for 9x9x25 nm Q switch: 1.3 - 1.5 kV
- Contrast Ratio: > 20 dB
- Clear Aperture: From 2x2 to 15x15 mm
- Acceptance Angle: > 1 degree
- AR coatings: R < 0.2% at 1064 nm
- Damage threshold: > 600 MW/cm² at 1064 nm ($\tau=10$ ns)

Part Numbers: STR-O-CR-L-E-W

STR means RTP EO Q-switches, O means the crystal's cutting orientation (X/Y/Z), CR means cross section, L means crystal length, E means extinction ratio in dB (20, 23, 25 or 30), W means wavelength.

Selection Guide

Part number	Crystal size (mm)	HWV (kV)	Part number	Crystal size (mm)	HWV (kV)
STR-Y-020-5-20-1064	2x2x5	1.3	STR-Y-020-10-20-1064	2x2x10	0.66
STR-Y-030-5-20-1064	3x3x5	2.0	STR-Y-030-10-20-1064	3x3x10	0.99
STR-Y-040-5-20-1064	4x4x5	2.6	STR-Y-040-10-20-1064	4x4x10	1.3
STR-Y-050-5-20-1064	5x5x5	3.3	STR-Y-050-10-20-1064	5x5x10	1.7
STR-Y-060-5-20-1064	6x6x5	4.0	STR-Y-060-10-20-1064	6x6x10	2.0
STR-X-020-5-20-1064	2x2x5	1.6	STR-X-020-10-20-1064	2x2x10	0.79

STR-X-030-5-20-1064	3x3x5	2.4	STR-X-030-10-20-1064	3x3x10	1.2
STR-X-040-5-20-1064	4x4x5	3.2	STR-X-040-10-20-1064	4x4x10	1.6
STR-X-050-5-20-1064	5x5x5	4.0	STR-X-050-10-20-1064	5x5x10	2.0
STR-X-060-5-20-1064	6x6x5	4.8	STR-X-060-10-20-1064	6x6x10	2.4
STR-X-070-5-20-1064	7x7x5	5.6	STR-X-070-10-20-1064	7x7x10	2.8
STR-X-080-5-20-1064	8x8x5	6.4	STR-X-080-10-20-1064	8x8x10	3.2
STR-X-090-5-20-1064	9x9x5	7.2	STR-X-090-10-20-1064	9x9x10	3.6

RTP Q-switch working at 30kHz

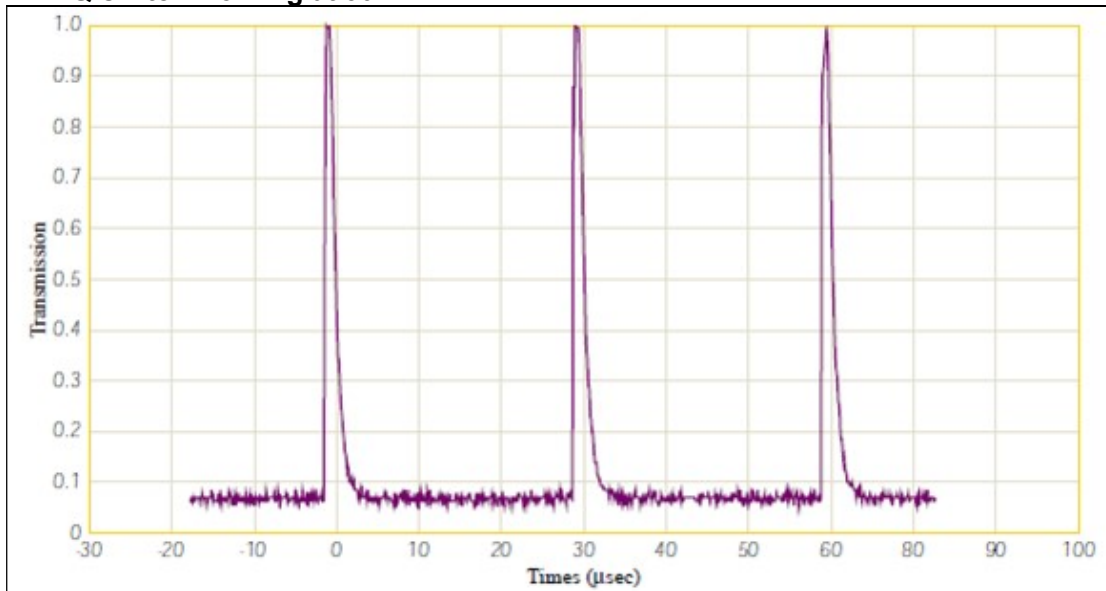

BBO Q-switch working at 30kHz

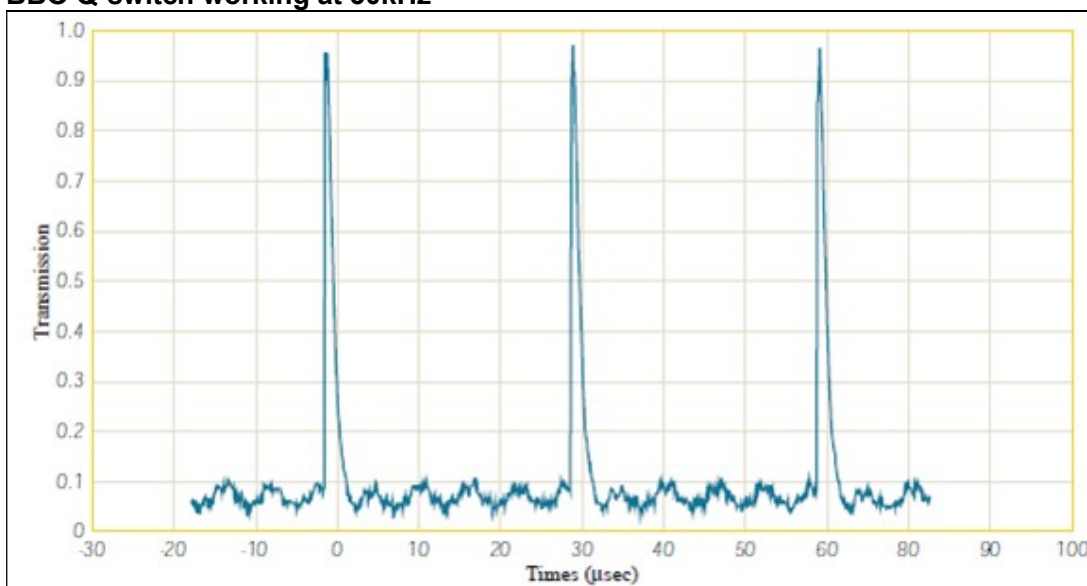

The graphs above show the behaviour of RTP and BBO Q switches at high repetition rates. In particular, the BBO shows Piezoelectric ringing at 30 kHz, while the RTP Q switch shows no ringing at this frequency. The BBO Q switch has a 2.5x2.5x25 mm element, while the RTP Q switch has two 6x6x7mm elements.

STC Series Pockels Cells (Acousto-optic Q-switches)

1. STC Series BBO Pockels Cells

- Minimal piezoelectric ringing
- Low absorption
- Broad transmission ranges from 200nm to 2000nm
- Compact size

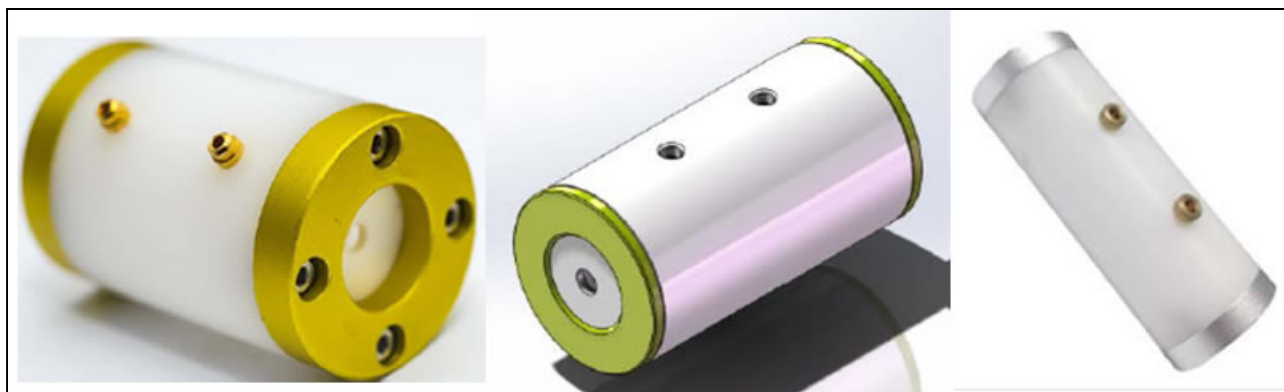

Part Number	STC-BBO1.8	STC-BBO2.5	STC-BBO3.6	STC-BBO2.8
Dimensions	25.4×39	25.4×39	25.4×39	20X37.5
Clear Aperture	1.8	2.5	3.6	2.8
Crystal Size	2*2*20	3*3*20	4*4*20	3X3X20
Quantity of Crystals	1	1	1	1
Wavelength range	410-3500nm	410-3500nm	410-3500nm	410-3500nm
Quarter-Wave Voltage	2400	3600	4800	3600
Operation Wavelength	1064nm	1064nm	1064nm	1064NM
Electrodes	Gold-coated PIN	Gold-coated PIN	Gold-coated PIN	Gold-coated PIN
Insertion Loss	<2%	<2%	<2%	<2%
Extinction Ratio	> 1000:1	> 1000:1	> 1000:1	> 1000:1
Capacitance	>4	>4	>4	>4
LIDT@1064nm,10ns 10Hz	500MW/cm ²	500MW/cm ²	500MW/cm ²	>600MW/cm ²

Part Number	STC-2BBO1.8	STC-2BBO2.5	STC-2BBO3.6
Dimensions	25.4×67	25.4×67	25.4×67
Clear Aperture	1.8	2.5	3.6
Crystal Size	2*2*20	3*3*20	4*4*20
Quantity of Crystals	2	2	2
Wavelength range	410-3500nm	410-3500nm	410-3500nm
Quarter-Wave Voltage	1200	1800	2400
Operation Wavelength	1064nm	1064nm	1064nm
Electrodes	Gold-coated PIN	Gold-coated PIN	Gold-coated PIN
Insertion Loss	<2%	<2%	<2%
Extinction Ratio	> 500:1	> 500:1	> 500:1
Capacitance	>4	>4	>4
LIDT@1064nm,10ns 10Hz	500MW/cm ²	500MW/cm ²	500MW/cm ²

2. STC Series LiNbO3 Pockels Cells

Our optical grade LiNbO₃ crystal has good electro-optic performance, large nonlinear coefficient, good optical uniformity, stable mechanical and chemical properties, no deliquescent, low half-wave voltage, and can be applied to high repetition rate operation. It is high in extinction ratio and laser damage threshold. LN electro-optic Q-switches are widely used in Er:YAG, Ho:YAG, Tm:YAG lasers, and are suitable for low-power Q-switched output, especially in laser ranging. We offer the most compact Q-

switches for our customers. Furthermore, we also can custom-design and make the Q-switches according to your specific requirements to meet your various applications.

- Large nonlinear optical coefficient
- Large receiving angle
- Small walk-off angle
- Wide temperature and spectral bandwidth
- High photoelectric coefficient and low dielectric constant
- Non-absorbent, stable chemical and mechanical properties

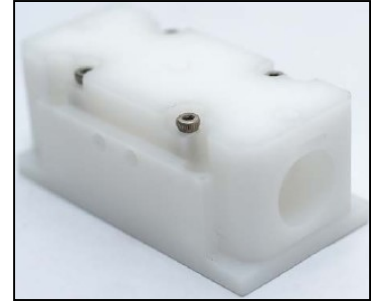

Part Number	STC-032855G1	STC-052855G1	STC-082855G1	STC-092855G1
Dimensions, LxWxH, mm	55x28x24	55x28x24	55x28x24	55x28x24
Clear Aperture, CA, mm	2.5	5	8	9
Crystal Size, mm	3x3x25	6x6x25	9x9x25	10x10x25
Quantity of Crystals	1	1	1	1
Wavefront Distortion	$\lambda/8@633\text{nm}$			
Quarter-Wave Voltage, V	885	1400	2400	2700
Operation Wavelength	1064nm			
Electrodes	Cu/Cr PIN			
Insertion Loss	<3%			
Extinction Ratio	>500:1 (LN); >200:1 (MgO:LN)			
Capacitance, pF	<5			
LIDT@1064nm,10ns 10Hz	>100MW/cm ² (LN); >300MW/cm ² (MgO:LN)			

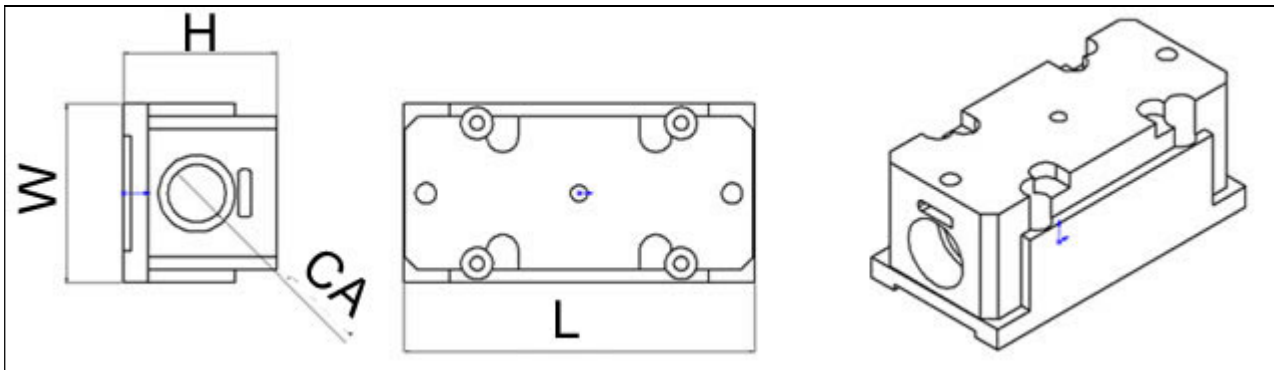

3. STC Series DKDP Pockels Cells

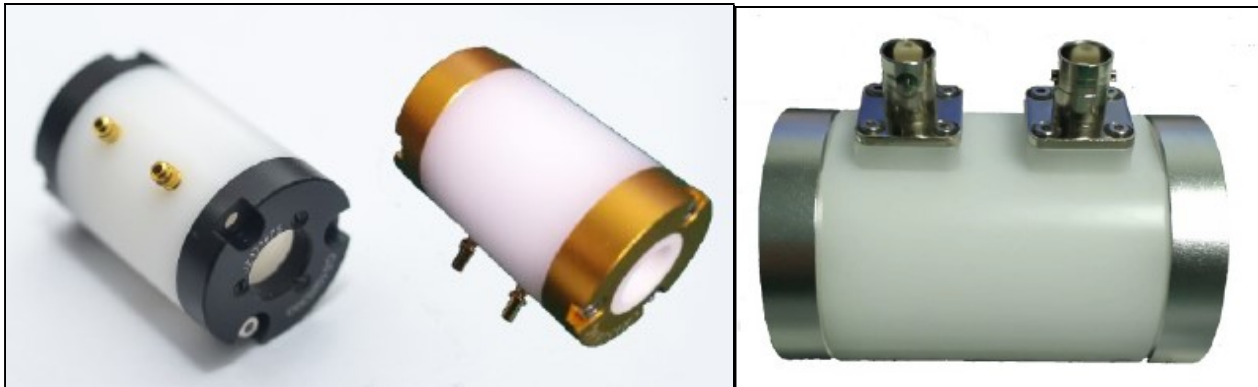

DKDP electro-optic Q-switches (Q-switch, Pockels Cells) are widely used in high-power, narrow-pulse (<10ns) laser systems due to their unique physical properties and excellent optical quality.

The DKDP crystal is a uniaxial crystal with excellent optical quality with an extinction ratio of >2000:1 (measured using a 632 nm He-Ne laser) with a wave front distortion of 98%. The DKDP electro-optic Q-switching capacitance is small (about 3-5pF), so that the rise time is short (<0.5ns), and a narrow pulse width laser beam can be achieved during Q-switching. Compared with the widely used electro-optic crystals on the market, DKDP crystals have higher damage thresholds (>1GW/cm²) under optical conditions of 10ns pulse width, 1064 nm wavelength and repetition rate 10Hz.

- Wave front distortion: low capacitance
- Short rise time: ~3pf
- High transmittance: >98%
- High damage threshold: >1GW/cm²
- No static birefringence, no photorefractive damage
- Anti-reflective coated quartz window
- Resistant to ambient temperature shock and excellent electro-optic performance

Part Number	STC-DK10	STC-DK12	STC-DK25	STC-DK30	STC-DK50
Dimension	D25x39mm	D25x39mm	D55X80	D55X80	NIL
Clear Aperture	10mm	12mm	25mm	30mm	50mm
Quarter-wave Voltage	3200V	3200V	6500V	6800V	7500V
Electrodes	PIN	PIN	Cu/Cr	Cu/Cr	Cu/Cr
Insertion Loss	<2%	<2%	<2%	<3%	<5%
Extinction Ratio	>2500:1	>2500:1	>155:1	>1000:1	>700:1
Capacitance	<5 pF	<5 pF	<12pF	<15pF	<35pF
LIDT @1064nm, 10ns, 10Hz	>800MW/cm ²	>800MW/cm ²	>850MW/cm ² ; >1GW/cm ² @500ps	>850MW/cm ² ; >1GW/cm ² @500ps	>850MW/cm ² ; >1GW/cm ² @500ps

We can custom-design and –make specific Q-switches such as cubic outlook, nitrogen encapsulated, lead-wire electrodes etc. Please send us your detailed requirements via email or phone.



STEK Series Pockels Cells

1. STEK-series KTP Pockels Cells

New STEK-PCK series KTP Pockels are based on specially grown high resistivity KTP crystals. KTP crystals have better optical homogeneity and higher damage threshold comparing to RTP crystals. The outstanding feature is a possibility to operate KTP Pockels cells at high duty cycles or even to keep at high voltage for the longer time.

Applications:

- Q-switching for high repetition rate lasers 1 kHz – 1 MHz
- Pulse picking of high repetition rate lasers

Features:

- More than twice smaller HV requirement comparing to double BBO Pockels cells
- Operates at high duty cycles
- Very low piezo-electric resonances
- Standard available apertures: 4x4, 6x6 and 8x8 mm



Model	STEK-PCK4	STEK-PCK4-O
Clear aperture diameter, mm		3.5
Crystal size (WxHxL), mm		4x4x10
Quantity of crystals		2
Half-wave voltage (@ 1064 nm), kV DC		<1.8
Capacitance, pF		4
Optical transmission, %		>98
Contrast ratio		>1:500
Cell size, mm	Ø25.4x42.2	25x11.1x7.5

Model	STEK-PCK6	STEK-PCK6-O
Clear aperture diameter, mm		5.5
Crystal size (WxHxL), mm		6x6x10
Quantity of crystals		2
Half-wave voltage (@ 1064 nm), kV DC		<2.5
Capacitance, pF		<6
Optical transmission, %		>98
Contrast ratio		>1:500
Cell size, mm	Ø25.4x42.2	25x13.8x10.6

2. STEK-series KD*P Pockels Cells

Pockels cells are used to change the polarization state of light passing through it when a voltage is applied to the electrodes of electro-optic crystals such as KD*P. When used in conjunction with polarizer, Pockels cells can be used as fast optical switches. Typical applications include Q-switching of the laser cavity, laser cavity dumping and coupling light into and from regenerative amplifiers. KD*P based Pockels cells are routinely used for Q-switching applications from the 400 nm to about 1.1 μm. Most of commercial flashlamp pumped Nd:YAG lasers and low repetition rate DPSS Nd:YAG lasers are

equipped with KD*P based Pockels cell for laser cavity Q-switching. Electro-optical KD*P crystals have high laser power resistant dielectric AR coatings. Additionally STEK-PC12SR and STEK-D-compact series Pockels cells have AR coated windows for improved lifetime and protection in less user friendly environment.

- Economically priced
- Compact size
- Low absorption
- Transmission from 400 to 1100 nm

Applications:

- Q-switching of the laser cavity
- Cavity Dumping



Model	STEK-PC5S	STEK-PC5D	STEK-PC10S	STEK-D-Compact/ 9	STEK-D-Compact/12
Clear aperture, mm	4.5x4.5	4.5x4.5	9.5x9.5	Ø8	Ø11
Crystal size, (WxHxL)mm	5x5x16	5x5x16	10x10x25	Ø9x20	Ø12x24
Quantity of crystals	1	2	1	1	1
$\lambda/2$ voltage 1064nm, kV DC	<6.5	<3.4	<6.8	<6.8	<6.8
Capacitance, pF	1.5	3	4	6	6
Optical transmission, %	>97	>97	>97	>97	>97
Contrast ratio ¹⁾	> 1:2000	>1:1000	>1:2000	>1:2000	>1:2000
Cell size, mm	18x14x25	23x16x52	22x18x33	Ø25.4x35	Ø25.4x39

¹⁾ Measured by crossed polarizers method

Crystals are coated AR/AR@1064 nm. Other antireflection coatings are available under request. Damage threshold >5 J/cm² for 10 ns pulses at 1064 nm.

Model	STEK-PC12SR	STEK-PCR12SR-532	STEK-PCR12SR-694
Clear aperture, mm	Ø 11	Ø 11	Ø 11
Crystal size, (WxHxL)mm	Ø 12x24	Ø 12x24	Ø 12x24
Quantity of crystals	1	1	1
$\lambda/2$ voltage	@1064 nm <6.8 kV DC	@532 nm <3.5 kV DC	@694 nm <4.5 kV DC
Capacitance, pF	6	6	6
Optical transmission, %	>97	>96	>97
Contrast ratio ¹⁾	>1:2000	>1:2000	>1:2000
Cell size, mm	Ø 35 x 41.4	Ø 35 x 41.4	Ø 35 x 41.4

¹⁾ Measured by crossed polarizers method

3. STEK Series BBO Pockels Cells

Pockels cell are used to change the polarization state of light passing through it when a voltage is applied to the electrodes of electro-optic crystals such as BBO. When used in conjunction with polarizer, Pockels cells can be used as fast optical switches. Typical applications include Q-switching of the laser cavity, laser cavity dumping and coupling light into and from regenerative amplifiers.

BBO based Pockels cells can be useful at wavelengths from the UV to more than 2 μ m. Low piezoelectric ringing makes these Pockels cells attractive for the control of high-power and high pulse repetition rate lasers. Fast switching electronic drivers properly matched to the cell are available for Q-

switching, cavity dumping and other applications. Pockels cells of PCB series are transverse field devices. Low electro-optical coefficient of BBO results in high operating voltages. The quarter-wave voltage is proportional to the ratio of electrode spacing and crystal length. As a result, smaller aperture devices have lower quarter-wave, however even for 2.5 mm aperture devices the quarter-wave voltage is as high as 4 kV @ 1064 nm. Double crystal design is employed to reduce required voltages and to allow operation in half-wave mode with fast switching times

Features:

- minimal piezoelectric ringing
- low absorption
- ceramic aperture is available
- broad transmission range from 200 nm to 2000 nm
- compact size

Applications:

- high repetition rate DPSS Q-switch
- high repetition rate regenerative amplifier control
- cavity dumping
- beam chopper

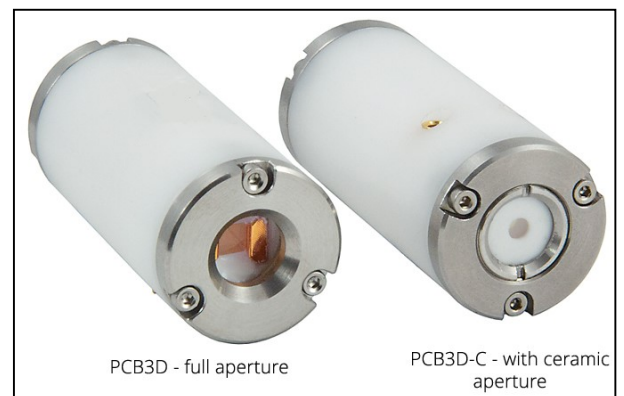

Model	STEK-PCB3S	STEK-PCB3D	STEK-PCB3S/25	STEK-PCB3D/25	STEK-PCB4S	STEK-PCB4D
Clear aperture diameter, mm	2.5	2.5	2.5	2.5	3.5	3.5
Crystal size (WxHxL), mm	3x3x20	3x3x20	3x3x25	3x3x25	4x4x20	4x4x20
Quantity of crystals	1	2	1	2	1	2
Quarter-wave voltage (@ 1064 nm), kV DC	<3.5	<1.8	<3.0	<1.5	<4.6	<2.3
Capacitance, pF	4	6	4	6	3	6
Optical transmission, %	>98	>98	>98	>98	>98	>98
Contrast ratio ¹⁾	>1:1000	>1:500	>1:1000	>1:500	>1:1000	>1:500
Cell size, mm	Ø25.4x37.2	Ø25.4x57.2	Ø25.4x42.2	Ø25.4x67.2	Ø25.4x37.2	Ø25.4x57.2

All crystals for the Pockels cells provided above are coated AR/AR@1064 nm. Other antireflection coatings are available under request. Damage threshold >5 J/cm² for 10 ns pulses at 1064 nm.

Model	STEK-PCB3S-1342	STEK-PCB3D-800	STEK-PCB3S-532
Clear aperture diameter, mm	2.5	2.5	2.5
Crystal size (WxHxL), mm	3x3x20	3x3x20	4x4x20
Quantity of crystals	2	1	1
Quarter-wave voltage, kV DC	<2.4	<2.6	<2.25
Wavelength, nm	1342	800	532
Capacitance, pF	4	6	4
Optical transmission, %	>98	>98	>98
Contrast ratio ¹⁾	>1:500	>1:1000	>1:1000
Cell size, mm	Ø25.4x57.2	Ø25.4x37.2	Ø25.4x37.2

¹⁾ Measured by crossed polarizers method

EO Q-switch Drivers

1. STG-551 Pockels Cell Driver



The driver STG-551 is designed for use in product development, teaching and research laboratories. Housed in a compact 100x125x50 mm (5x5x2") aluminium case, the driver has a full suite of controls, indicators and remote control features. It operates from an external 24VDC source (power adapter included).

A unique feature of the driver is its differential bipolar output-reducing voltage to ground and shock hazard, as important feature in a laboratory environment. Leads to the pockels cell leave from the back of the case, keeping them away from hands at the front panel. The driver outputs are short-circuit proof. The driver is designed for reliability with low component stresses, the highest quality components and the use of US Navy derating standard.

An OEM version with the same electrical performance is available for inclusion in the laser product.

Features:

- 4-7ns, 1.5-4.5kV, 1Hz-4.5kHz performance
- 50 ohm isolated trigger
- Front panel controls for high voltage setpoint and power
- DB-9 connector with: voltage monitor, remote setpoint, voltage on/off
- Status LEDs for power, high voltage and trigger

Benefits

- Front panel or remote control
- Short-circuit protected output
- Easy integration of OEM version
- EM shielding enclosure

Applications

- Ideal for development of Q-switched lasers for:
 - Medical and dermatology
 - Imaging
 - Engraving
 - Metal cutting
 - Microfabrication
 - Range finding
 - Holography

Specifications

Parameter	Conditions	Min	Max	Units
OUTPUT PULSE PARAMETERS				
Pulse top	4kV output, 6pF cell capacitance		150 (nom)	ns
Delay time constant	4kV output, 6pF cell capacitance		5 (nom)	μ
Pulse voltage	Limits of adjustment	1.5	4.5	kV
Load capacitance			25	pF
POWER REQUIREMENTS				
24 VDC	Power limit before output fold-back		130	mA
TRIGGER				
Trigger voltage		2	8	V
Input Impedance		48	52	ohms
Pulse width		200		ns
Jitter, trigger to output	2ns trigger rise time, Tektronix 11801		20 (nom)	Ps RMS
ENVIRONMENTAL				
Temperature		-20	50	$^{\circ}$ C

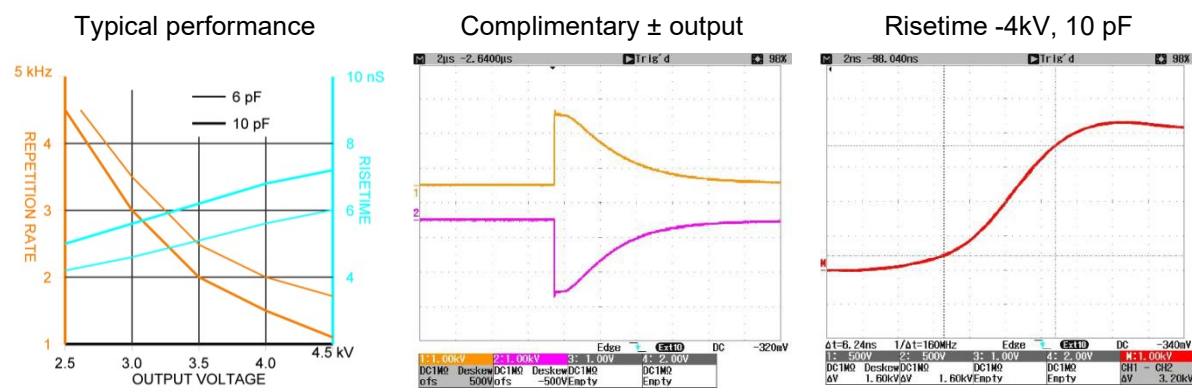

2. STG-551-OEM Pockels Cell Driver

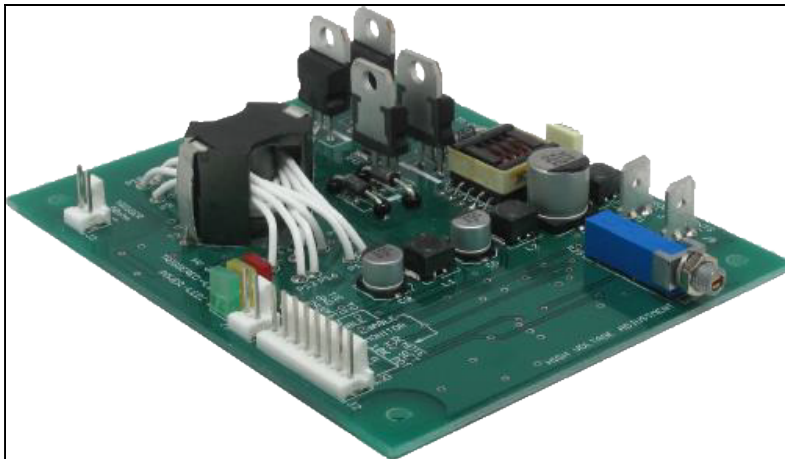

The OEM driver is a cost effective, high performance Pockels cell driver for incorporation into Q-switched laser systems. The driver is packaged on a compact 100x83 mm (4x3 $\frac{1}{4}$ ") circuit board. The driver is fully self-contained with the power supply and all control circuitry, needing only 24 VDC and a trigger signal to operate. Designed for reliability with low component stress and worst-case design margins, the driver meets specifications from 40C to +70C. It works with loads to 50 pF. G&H can supply the driver in different form factors for high volume applications. For more information please see the Design-In Manual.

Features

- 4-7 ns, 1.5-4.5 kV, 1Hz-4.5 kHz performance (see graph on following page)
- 50 ohm isolated trigger
- Voltage monitor
- Status LEDs for power, high voltage and trigger
- Remote on/off and voltage setpoint

- Bipolar balanced output
- 24 VDC input power
- Laboratory version available

Benefits

- Low power dissipation, less heat
- Remote control ready
- Compact footprint
- Easy integration

Applications

- Medical and dermatological laser systems
- Imaging
- Engraving
- Metal cutting
- Microfabrication
- Range finding
- Holography

Specifications

Parameter	Conditions	Min	Max	Units
OUTPUT PULSE PARAMETERS				
Pulse top	4kV output, 6pF cell capacitance		150 (nom)	ns
Delay time constant	4kV output, 6pF cell capacitance		5 (nom)	μ
Pulse voltage	Limits of adjustment	1.5	4.5	kV
Load capacitance			25	pF
POWER REQUIREMENTS				
24 VDC	Power limit before output fold-back		130	mA
TRIGGER				
Trigger voltage		2	8	V
Input Impedance		48	52	ohms
Pulse width		200		ns
Jitter, trigger to output	2ns trigger rise time, Tektronix 11801		20 (nom)	Ps RMS
ENVIRONMENTAL				
Temperature		-20	50	$^{\circ}$ C

Typical performance

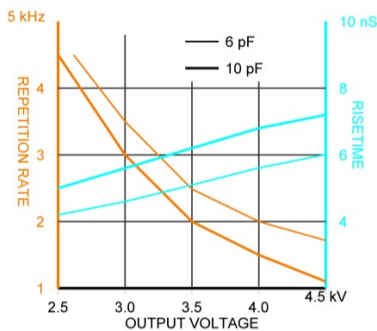

Complimentary \pm output

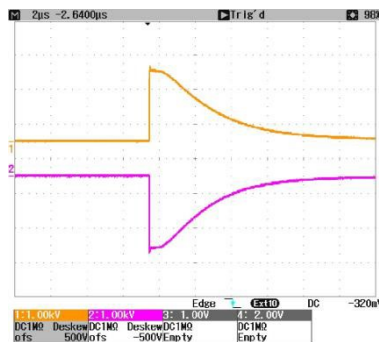

Risetime -4kV, 10 pF



Layout

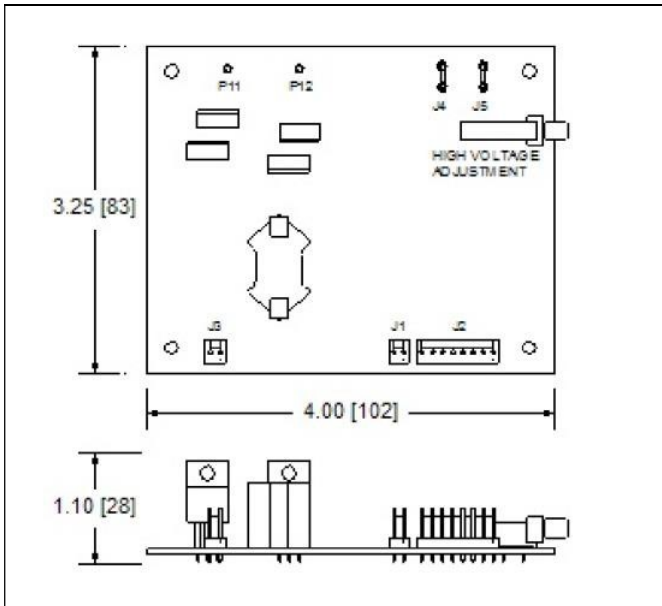

Dimensions of the driver board.

3. STG-R200-OEM Pockels Cell Driver

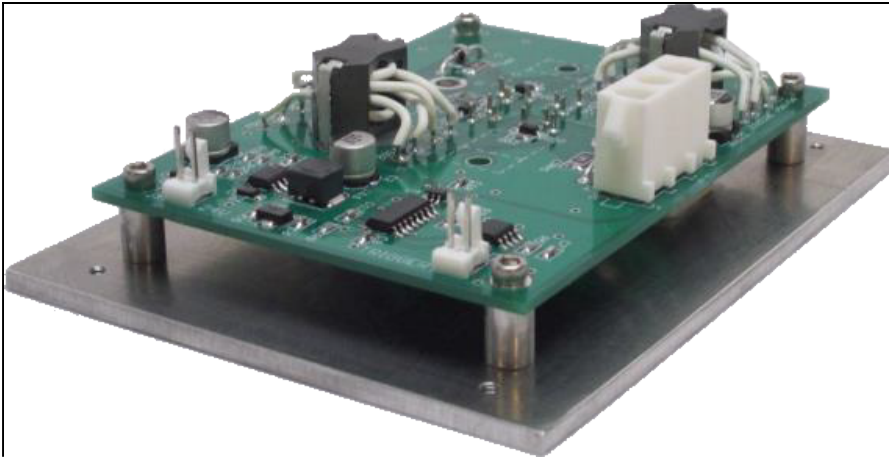

The OEM driver is a compact OEM Pockels cell driver for inclusion in regenerative amplifiers and other pulse selection applications in solid state laser systems. The unit drives Pockels cells at 1/4 wave producing pulses at up to 2.5 kV and up to 200 kHz, with burst mode capability to 1 MHz. The driver produces a top-hat waveform with fast rising and falling edges. Heat load and space requirements are kept at a minimum due to the use of external power supplies. The trigger input is also electrically isolated from the power supplies for safety. The compact 115x90x30 mm (4.5x3.5x1.2") circuit board is supplied on an aluminium plate for convection cooling, which can also be attached to a cold plate for water cooling. The R200 can also be supplied as a turn-key integrated 19" rack system for benchtop use.

Key Features

- 4-7 ns rise and fall time
- 0-2.5 kV output voltage
- 0-200 kHz repetition rate
- 250 ns 3 s pulse widths
- Bipolar balanced output

Benefits

- Available as a turn-key system with enclosure
- High performance at a low cost
- Can be air or water cooled
- Compact footprint

Applications

- Metal cutting
- Welding
- Glass and sapphire cutting
- Spectroscopy

Specifications

Parameter	Conditions	Min	Max	Units
OUTPUT PULSE PARAMETERS				
Pulse repetition rate	Convection cooled	0	40	kHz
	Water cooled 1.5 L/min.	40	200	kHz
Pulse voltage	External HV: ± 625 VDC in for 2.5kV out	0	2.5	kV
Pulse width	Same as trigger input	250	3,000	ns
Rise, fall times	2.0 kV, 6 pF		6.0	ns
	2.0 kV, 40 pF max load		9.5	ns
POWER REQUIREMENTS				
Input voltage, current	24 VDC (± 2 VDC)		200	mA
High voltage, current	2.5 kV out, ± 625 VDC in, 200 kHz, 6 pF		55	mA
TRIGGER				
Trigger amplitude Input	Nom. 5 V, 50 Ω Impedance	4	10	V
Trigger to output delay	5 V trigger		40	ns
Trigger pulse width	Sets output pulse width	250	3,000	ns
Jitter, trigger to output	2 ns trigger rise time, Tektronix 11801		20 nom	ps RMS
ENVIRONMENTAL				
Mounting surface*			50	$^{\circ}$ C

*Mounting plate should be attached to a thermally conductive surface for cooling or to a cold plate for water cooling.

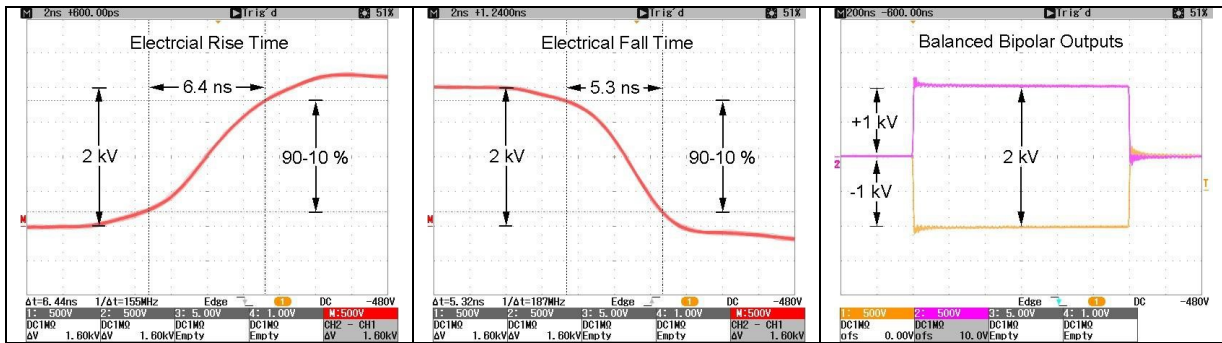

Layout

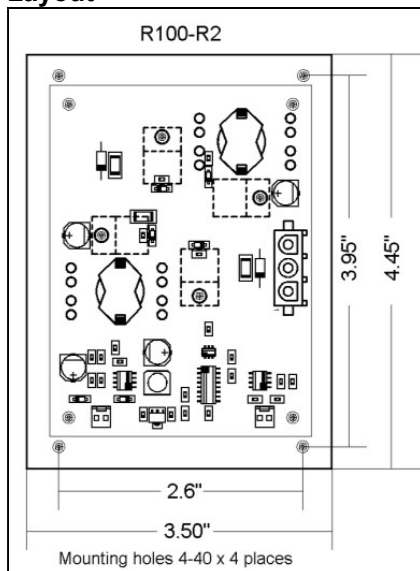

3. STG-QDP50-OEM Pockels Cell Driver

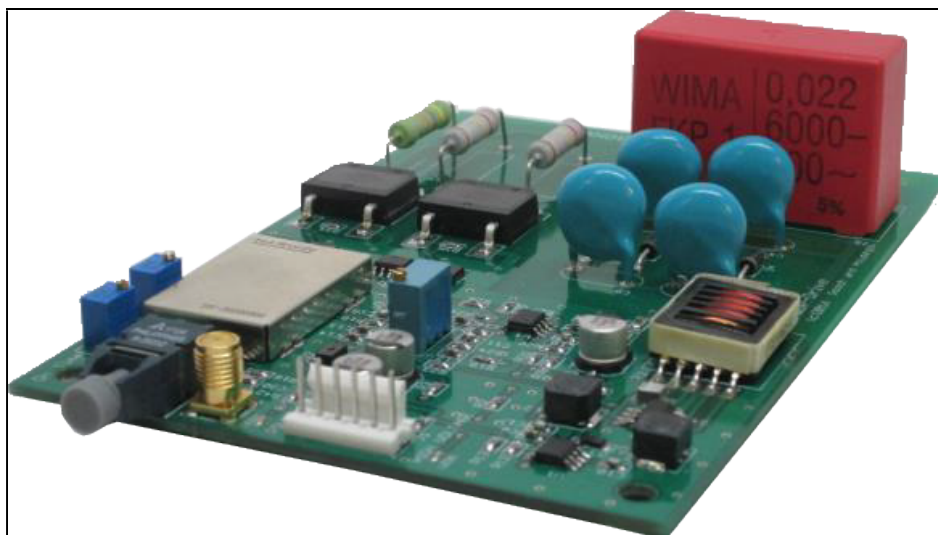

The OEM driver is a compact OEM Pockels cell driver for inclusion in flash lamp pumped lasers. The driver is designed for Q-switching of lasers without the need for phase retardation plates. Once triggered, high voltage is applied to inhibit the laser output. After a preset delay, the Pockels cell is opened by a fast negative pulse to allow laser output, then it returns to high voltage to inhibit additional lasing.

The QDP-50 has been shown to increase Pockels cell life expectancy and laser output power relative to voltage-on scenarios often employed. It can be triggered via an SMA connector or via an optional optical input for greater noise immunity.

The compact 140x92x32 mm (5.5x3.6x1.2") circuit features an integrated high voltage power supply which includes remote voltage monitoring (1 V/kV) and remote shutdown.

Key Features

- 1.2-4.0 kV adjustable output voltage
- 0-50 Hz repetition rate
- 400 μ s nominal on time (adjustable)
- 160-200 μ s delayed pulse (adjustable)
- Fall time (delay pulse) less than 10 ns
- SMA trigger input standard
- Optical trigger input (optional)

Benefits

- Increased Pockels cell life
- High performance at a low cost
- Integrated high voltage power supply
- Compact footprint

Applications

- Medical lasers
- Industrial lasers
- Etching/marking

Specifications

Parameter	Conditions	Min	Max	Units
OUTPUT PULSE PARAMETERS				
Pulse repetition rate	Same as trigger input	1	50	Hz
Amplitude (V1+V2)	Adjustable (V2 = 10% of V1)	1.2	4.0	kV
Total HV on time	Adjustable or fixed	300	600	μ s
Delayed center pulse	Adjustable (range can be modified)	160	200	μ s
Rise time	3.5 kV, 6 pF	1	5	μ s

Fall time	3.5 kV, 6 pF		< 10	ns
Load capacitance	With Pockels cell leads		30	pF
POWER REQUIREMENTS				
Input voltage	Exceeding 20 VDC will damage driver	15	18	VDC
Input current	4.0 kV, 50 Hz, 10pf load		250	mA
TRIGGER				
Input impedance	Nom. 50 Ω	48	52	ohms
Amplitude	Nom. 5 V	4	10	V
Pulse width	Set by user	100n	10m	sec
Propagation delay	After trailing edge of trigger	80	100	ns
ENVIRONMENTAL				
Ambient air temperature			50	$^{\circ}\text{C}$

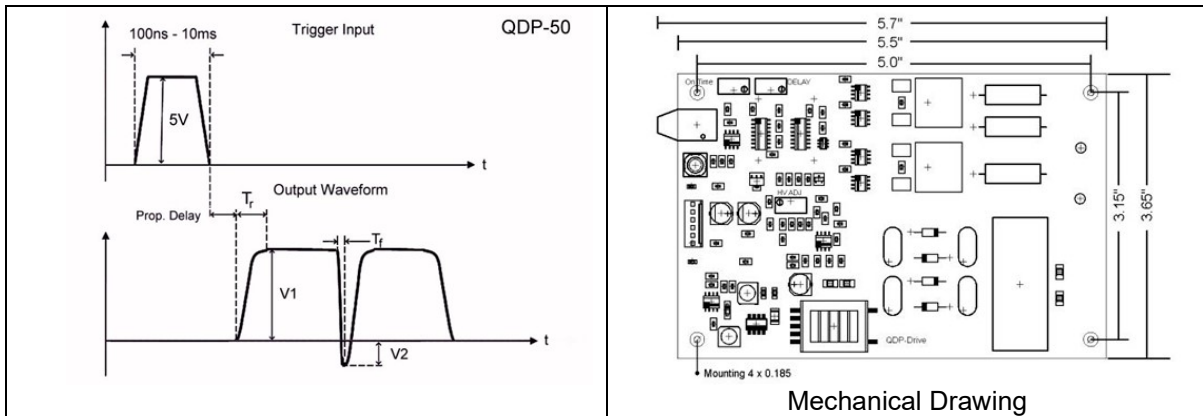

5. STG-HVR OEM Pockels Cell Driver

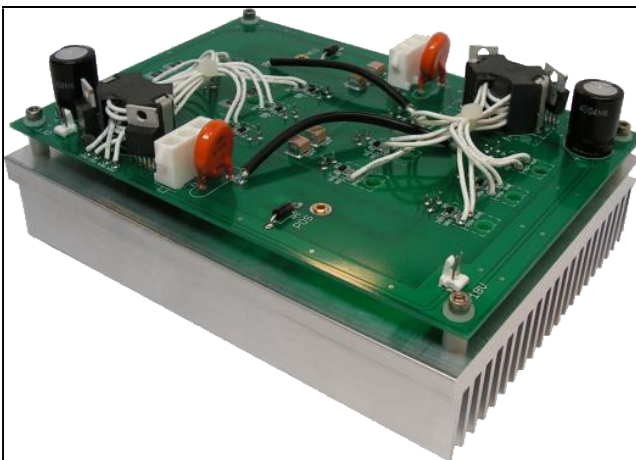

The OEM driver is designed to switch Pockels cells used for pulse management in high repetition rate ultrafast laser regenerative amplifiers. The HVR drive can drive Pockels cells at $1/4 \lambda$ or $1/2 \lambda$ up to 7.5 kV and up to 200 kHz. The driver produces a top-hat waveform with fast rising and falling edges. Heat load and space requirements are at a minimum due to the use of external power supplies and control electronics.

The HVR driver measures 136.5x178x70 mm (5.375x7.0x2.8") with the standard heat sink for convection cooling. It can also be air-cooled or water-cooled for higher repetition rates. We can supply the driver in different form factors for high volume applications. On/Off trigger inputs can be standard TTL signals or optional optical trigger inputs can be supplied.

We can work with you to customize the driver for your specific application. Options such as remote monitoring, remote shutdown and over temperature indicators can be supplied.

Key Features

- 0 200 kHz repetition rate pulses
- 1.0 7.5 kV output voltage

- 10 15 ns rise and fall times
- 250 ns 3 μ s pulse widths
- Bipolar balanced output

Key Benefits

- Compact footprint
- Reduced heat load
- Easy integration
- Flexible design

Applications

- Metal cutting
- Welding
- Glass cutting
- Sapphire cutting
- Spectroscopy

Specifications

Parameter	Conditions	Min	Max	Units
OUTPUT PULSE PARAMETERS				
Repetition rate	7.5 kV, 10 pF, water cooled ²		100	kHz
	6.0 kV, 10 pF, water cooled		150	kHz
	5.0 kV, 10 pF, water cooled		200	kHz
Duty cycle	Ratio of pulse width to period (1/frequency)		20	%
Pulse amplitude		1.0	7.5	kV
Rise/fall times		10	15	ns
POWER REQUIREMENTS				
Low voltage supply		15.0	18.0	VDC
Low voltage supply	200 kHz rep rate		300	mA
2 x high voltage supplies	For 7.5kV out, external \pm 1875 VDC required ¹		100	mA
TRIGGER				
On/Off trigger voltage	Normally 5 V, TTL	4	15	V
Trigger to output delay	5 V trigger		60	ns
Pulse width	(subject to 20% duty cycle maximum)	250	3000	ns
Jitter, trigger to output	2 ns trigger rise time		50	ps
ENVIRONMENTAL				
Operating ambient		0	50	$^{\circ}$ C

NOTES

Two external high voltage power supplies are required; one positive output, one negative output. For example, to achieve 6 kV output you will need \pm 1500 VDC input.

1. High voltage current requirements are determined by the pulse width and repetition rate. Rise and fall times vary with output voltage; higher voltages produce longer rise and fall times.
2. Convection cooled, the maximum rep rate is 25 kHz @ 7.5 kV, 37.5 kHz @ 6 kV and 50 kHz @ 5 kV. Water cooled, chiller set to 24 $^{\circ}$ C, flow rate to 1.5 gal/minute (6L/min) nominal.

CAUTIONS

Do not connect the outputs to ground or damage to the driver will occur.
The low voltage supply must be on before applying the high voltage inputs.
The On/Off triggers must not overlap or damage to the driver will occur.

6. STG-HVR-SYSTEM Pockels Cell Driver

The HVR-SYSTEM is a turn-key integrated driver and control system to switch Pockels cells used for pulse management in high repetition rate ultrafast laser regenerative amplifiers.

The driver can drive Pockels cells at $1/4\lambda$ or $1/2\lambda$ up to 7.5kV and up to 200 kHz. The driver produces a top-hat waveform with fast rising and falling edges. The driver operated from any 88-264VAC, 50-60Hz input, it requires only an AC source and a TTL signal to operate. A built-in digital voltmeter allows you to set the output voltage before applying it to the driver and separate high voltage enable/disable buttons

are standard for added safety. A separate trigger on/off switch provides easy pulse control which also disables the high voltage at the rear panel output connectors.

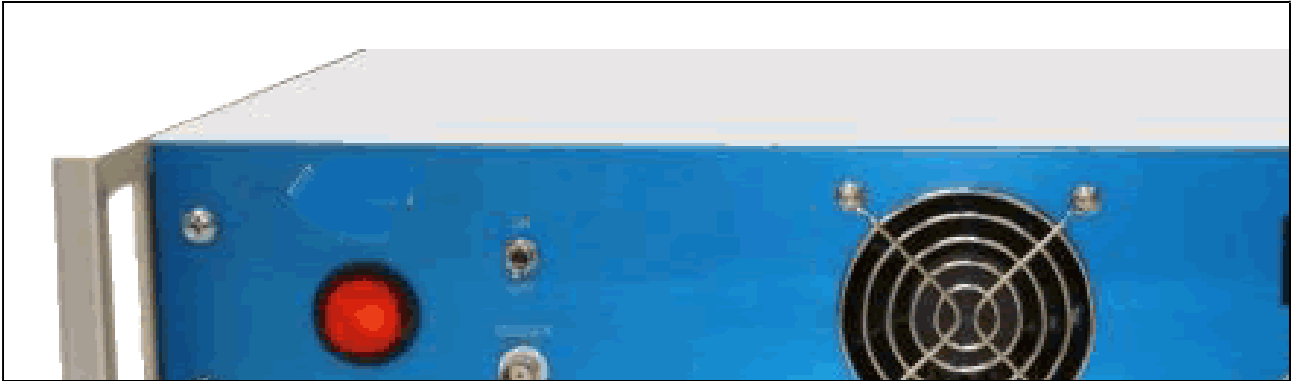

The driver comes in a standard 483mm (19") rack mount enclosure which can also be used as a benchtop unit. It comes with forced air cooling for operation up to 50 kHz or water-cooled for higher repetition rates.

We can work with you to customize the system for your specific application. Option such as optical triggering, remote control and over-temperature indicators can be supplied.

Key Features

- 0-50 kHz repetition rate (air-cooled)
- 0-200 kHz repetition rate (water-cooled)
- 1.0-7.5 kV output voltage
- 10-15 ns rise and fall times
- 250 ns-3 us pulse widths
- Bipolar balanced output
- Standard 483mm (19") rack mounting
- Dimensions: 432x381x95.25mm (17x15x3.75")

Key Benefits

- Turn-key driver solution
- Built in digital voltmeter
- Easy integration
- Flexible design

Applications

- Metal cutting
- Welding
- Glass cutting
- Sapphire cutting
- Spectroscopy

Specifications

Parameter	Conditions	Min	Max	Units
OUTPUT PULSE PARAMETERS				
Max pulse repetition rate	Air cooled		50	kHz
	Water cooled		200	kHz
Max duty cycle	Ratio if pulse width to period (1/freq)		20	%
Pulse amplitude		1.0	7.5	kV
Rise/fall times	6-10 pF output capacitance ¹	10	15	ns
POWER REQUIREMENTS				
Input voltage		88	264	mA
Input frequency		50	60	Hz
TRIGGER				
Voltage	Normally 5 V, 50 Ω input impedance	4	6	V
Trigger to output delay	5 V trigger		100	ns

Pulse width	(subject to 20% duty cycle maximum)	250	3000	ns
ENVIRONMENTAL				
Operating ambient		0	40	°C

1 Unit has been tested with up to a 100 pF load and demonstrated rise/fall times less than 40 ns

Standard Output Configurations

Amplitude	Maximum rep rate	Model number	Cooling method
0-6 kV	10 kHz	HVR-60010	Air
0-6 kV	30 kHz	HVR-60030	Air
0-6 kV	150 kHz	HVR-60150	Water
0-7.5 kV	5 kHz	HVR-75005	Air
0-7.5 kV	10 kHz (0-6 kV @ 20 kHz)	HVR-75010	Air
0-7.5 kV	100 kHz (0-5 kV @ 20 kHz)	HVR-75100	Water

7. STHVSW03-OEM Drivers

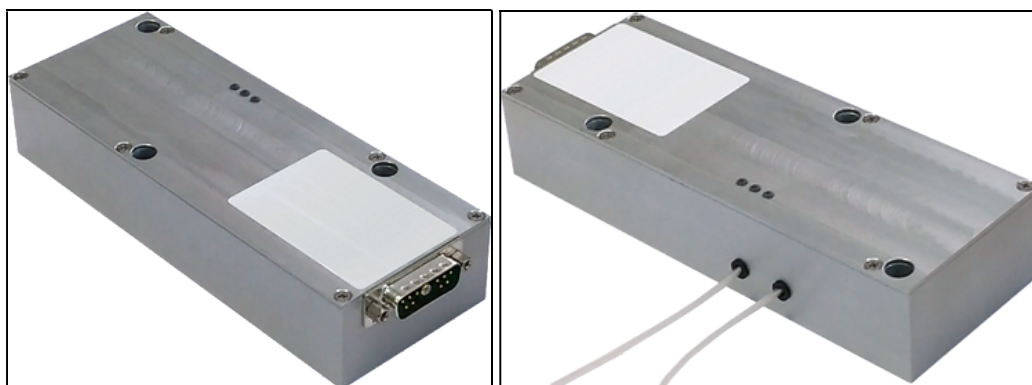

STHVSW03 is a specialized Pockels cell driver that performance is optimized for pico- and femtosecond lasers. Main applications are pulse picking and regenerative amplifier control. Maximal output voltage is 2kV; maximal repetition rate achieves 1MHz at 1.5kV output voltage and 2MHz at <1.0kV output voltage. Transition times are as fast as 5-7ns in dependence on load capacitance and driver's configuration. Pulse width is <15ns (fixed), then 100-2000ns (adjustable by the customer). Interfaces are analogue and RS-485. Configuration software for Windows® 7 is available.

Compact design (about 0.3dm³), conductive cooling through the bottom surface and embedded high voltage power supply (i.e. driver's input is +24V DC) are additional benefits.

Specifications

Input	+24V DC; 5.5A max
Output	Pulses of high voltage and high repetition rate delivered to the capacitive load (e.g. to the Pockels cell)
Output type	Bipolar
Pulse baseament ¹	0V, fixed
Pulse amplitude ^{1,2}	adjustable in 0-2kV range
Maximal repetition rate ²	Up to 1-2MHz (see also Performance section)
Minimal repetition rate	Single shot (there is an internal re-striking circuit which makes the operations at such a low repetition rate possible)
Pulse width	– Fixed, about 15ns in Fixed pulse width mode – 100ns-2000ns adjustable (customable) in Variable pulse width mode
Interpulse interval	>100ns
Risetime / falltime ³	5-7ns
Delay time	<50ns
Jitter	<0.5ns (±250ps)
Load capacitance	5-7pF typically
Protections	– From too long pulses (Gate limit), adjusted by the customer in 200ns to 2200ns range ³ – From overheating
Operation temperature	10 ~ 40°C
Storage temperature	-20 ~ +60 °C
Humidity	90%, non-condensing

Dimension	69x60x32mm
Weight	<0.5kg

- In terms of bipolar output (see also Technical notes section)
- Maximal pulse repetition rate depends on pulse amplitude, pulse amplitude and pulse repetition rate cannot achieve their maximums at the same time
- 10-90% level, warranted at load capacitance 11pF and below
- These and other parameters might be changed upon request.

Dimension

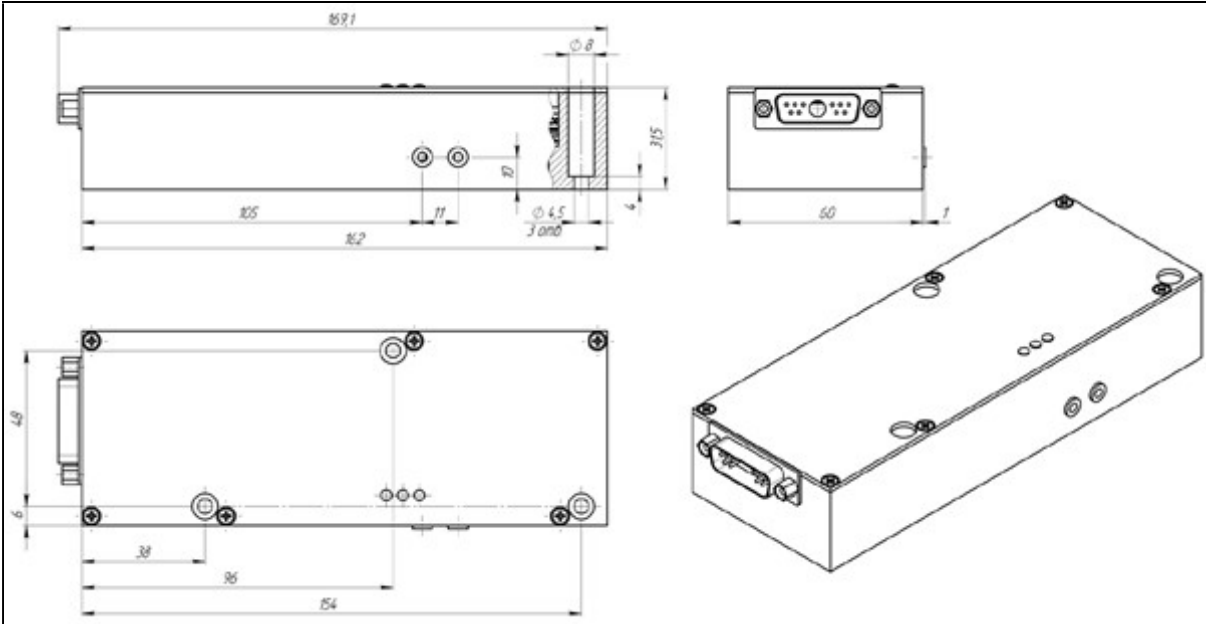

Performance

Driver's performance (i.e. the maximal possible repetition rate) depends on load capacitance, pulse amplitude and the performance of cooling system and limited with internal temperature (we do not recommend to exceed 80-90 °C transistor temperature) and the current consumption (we do not recommend to exceed 5A current consumption).

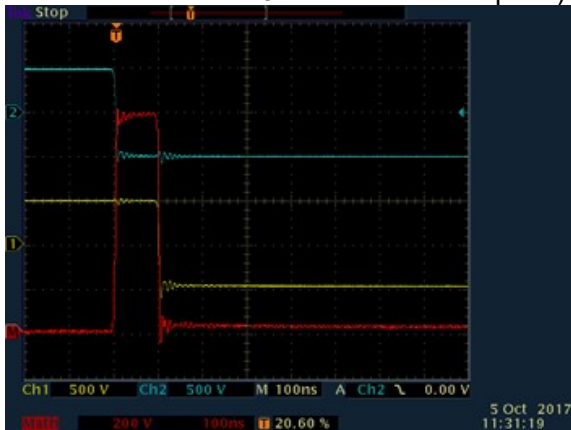

Pulse width mode - variable

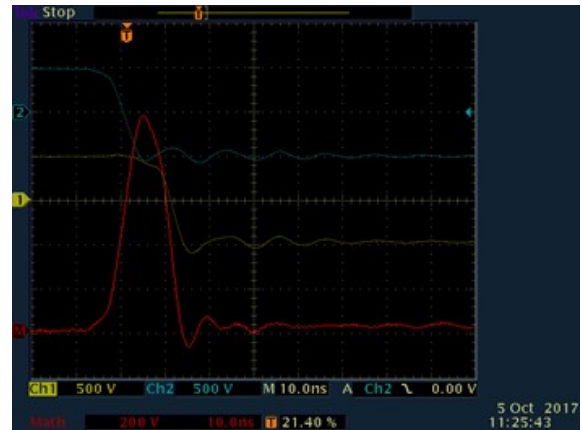

Pulse width mode - fixed

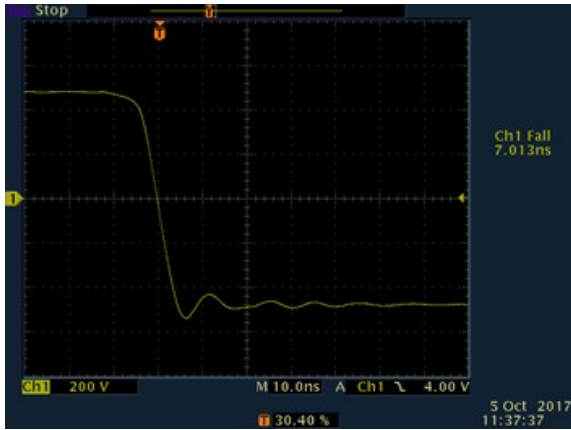

Triggering - soft

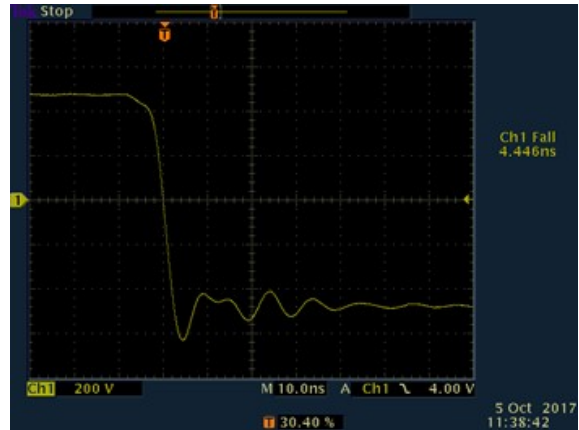

Triggering - harsh

8. STHVSW04-OEM Drivers

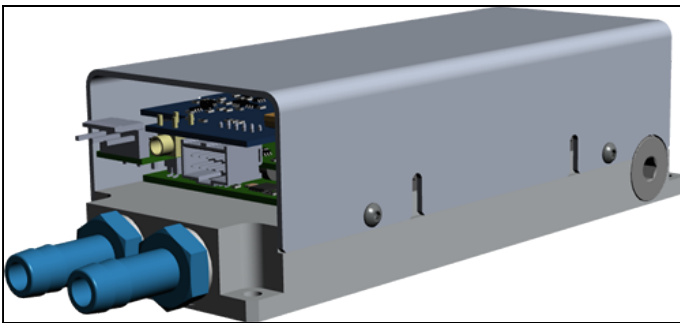

STHVSW-04 is a specialized Pockels cell driver that performance is optimized for pico- and femtosecond lasers. Main applications are pulse picking and regenerative amplifier control. Maximal output voltage is 4kV; maximal repetition rate is 4MHz at approx. 1.6kV output voltage and 1MHz at approx. 3.2kV output voltage. Target performance is as below:

- 1.6kV, 4MHz, <300W power consumption
- 3.2kV, 1MHz, <300W power consumption

Transition times are as fast as 5-7ns in dependence on load capacitance and driver's configuration. Pulse width is <15ns (fixed), then 100-2000ns (adjustable by the customer). For operations the driver needs both HV and LV power. HV DC input should be bi-polar. LV power is 24VDC, <2A. Module is water cooled. Different configurations of water inlets available on request. Interfaces are analogue and RS-485. Configuration software for Windows® 7 is available.

Specifications

LV input	+24V DC; 1.5A max
HV input	+HV/2 by one wire; -HV/2 by another wire
Output	Pulses of high voltage and high repetition rate delivered to the capacitive load (e.g. to the Pockels cell)
Output type	Bipolar
Pulse basement ¹	0V, fixed
Pulse amplitude ^{1,2}	adjustable in 0-4kV range
Maximal repetition rate ²	Up to 4MHz
Minimal repetition rate	Single shot (there is an internal re-striking circuit which makes the operations at such a low repetition rate possible)
Pulse width	– Fixed, about 15ns in Fixed pulse width mode – 100ns-2000ns adjustable (customable) in Variable pulse width mode
Interpulse interval	>100ns
Risetime / falltime ³	5-7ns
Delay time	<50ns
Jitter	<0.5ns (±250ps)
Load capacitance	5-7pF typically
Protections	– From too long pulses (Gate limit), adjusted by the customer in 200ns to 2200ns range ³ – From overheating

Operation temperature	10 ~ 40°C
Storage temperature	-20 ~ +60 °C
Humidity	90%, non-condensing
Dimension	69x60x32mm
Weight	<0,5kg

- In terms of bipolar output (see also Technical notes section)
- Maximal pulse repetition rate depends on pulse amplitude, pulse amplitude and pulse repetition rate cannot achieve their maximums at the same time
- 10-90% level, warranted at load capacitance 11pF and below
- These and other parameters might be changed upon request

Dimension

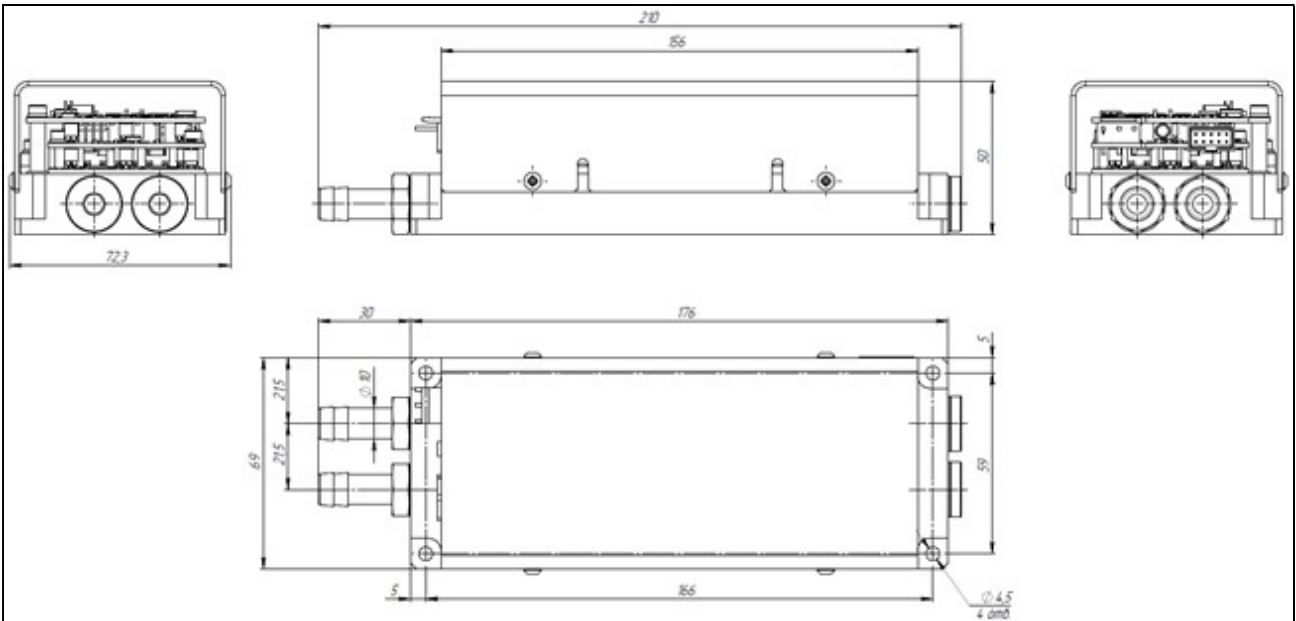

9. STQBD Series OEM Driver

STQBD is the series of high repetition rate Pockels cell drivers allowing simple and reliable operation of Q-switched lasers. Devices provide wide range of output direct voltages (up to 6 kV). It allows operation with Pockels cells assembled on different electrooptical crystals from low quarter-wave voltage Lithium Niobate and BBO to DKDP that requires much higher voltage levels for proper operation. QBD-series Pockels Cell Drivers have modifications both for pull-up and pull down schemes.

STQBD-Series devices provide high repetition rates (up to 100 kHz) that makes them a good solution for electro-optical Q-switched lasers with CW pumping. On the other hand a short rising (falling) time allows operation in short pulsed systems with high peak output power and energy (flashlamp-pumped Nd:YAG lasers).

Another advantage is the ability of operation with extremely high loads (up to 0.5 nF). This feature leads to higher reliability of the device and permits remote operation of Pockels cell in laser head that can be connected to driver using long cables (correct and effective operation has been approved with cables up to 3 meters). This allows the designing of Q-switched laser systems with compact remote laser heads where close placement of Pockels cell and driver is impossible because of volume insufficiency or other causes.

Features

- Compact OEM design
- Up to 6 kV output voltage
- Long cable operation
- Up to 100 kHz repetition rate
- Up to 0.5 nF load
- Pull-up and pull-down scheme modifications



Specifications

Input:	
Voltage	+24VDC
Output:	
Working modes	pull-down (= normally on) or push-up (= normally off)
Voltage, high level	regulated, up to 6 kV ¹
Voltage, low level	fixed, 0 V
Repetition rate	up to 50 kHz (CW), up to 100 kHz (burst-mode) ^{1, 2}
Load	up to 0.5 nF ¹
Rise time (Fall time)	< 20 ns ³
Recovery time	5-10 us (depends on load)
Jitter	10 ns
Delay time	1 us
Leakage current	not more than 150 uA
Environment:	
Operation temperature	0 ... +40 °C (-40 : +50 °C in HE modification)
Storage temperature	-20 ... +60 °C
Humidity	90 %, non-condensing
Size (LxWxH)	110x80x25 mm
Weight	0.1 kg

¹These parameters aren't independent and cannot achieve their maximum at the same time...

² forced air cooling is required for operating with high repetition rates...

³ 10-90% level; warranted at load capacitance 23 pF and below...

Part Number Description:

STQBD-XXYY-ZZ

STQBD – STQBD series EO Q-switch driver

XX – maximum output voltage from 20 to 60 (2 - 6kV)

YY – minimum output voltage from 12 to 20 (1.2 – 2.0kV)

ZZ – UP: modification for pull-up scheme; DN: modification for pull-down scheme

We offer five standard solutions:

STQBD-6024-UP/DN

STQBD-5020-UP/DN

STQBD-4016-UP/DN

STQBD-3012-UP/DN

STQBD-2008-UP/DN

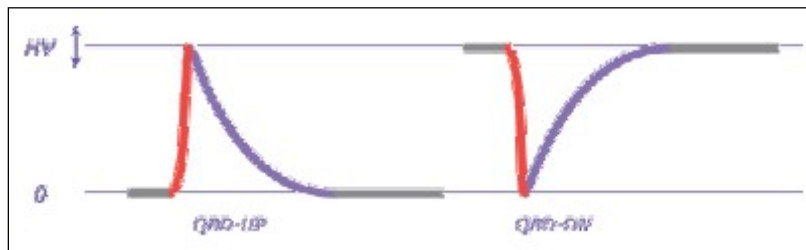

Options

Adjustment range of output voltage (see figure) can be selected within the following model series: STQBD-6024 (2.4-6 kV), STQBD-5020 (2-5 kV), STQBD-4016 (1.6-4 kV), STQBD-3012 (1.2-3 kV), STQBD-2008 (0.8- 2 kV).

STQBD-series Pockels cell drivers have two modifications: working by pull-up scheme or working by pull-down scheme.

Most of time gate is retained under voltage that is indicated in grey on figure; time of rapid growth/slump (20 ns) is indicated in red; time of relatively slow recovery (~10 us) is indicated in blue. Adjustable voltage level is designated by the arrow.

Applications

STQBD-Series Pockels Cell Drivers are available in standard and special versions. Standard modification is a relatively simple OEM device designated for operation in laboratory or medical laser systems at normal temperature and humidity conditions. These modules are designed in accordance with IEC60601-1 medical safety standard requirements. Output parameters (direct high voltage) are controlled by use of analog interface.

Special version is available for laser systems designated for operation in harsh environment. These

devices are distinguished due to wide operation temperature range, humidity and vibration steadiness. In this version all parameters are controlled by simple and reliable internal multi-turn trimpots.

10. STQBU Series OEM Drivers

STQBU is a series of multi-functional Pockels cell drivers of hi-end class. In contrast to analogues, they can provide rapid switching of input voltage in two directions: both up and down. STQBU-Series Pockels Cell Driver is extremely flexible solution for driving of the Pockels cell that works upon any user-defined scheme (that may be pull-up, pull-down schemes or any combinations of them).

Modules provide wide range of output direct voltages (up to 5 kV). It allows operation with Pockels cells assembled on different electrooptical crystals from low quarter-wave voltage Lithium Niobate and BBO to DKDP that requires much higher voltage levels for proper operation.

Moreover, STQBU-Series modules provide high repetition rates (up to 100 kHz) that makes them a good solution for electro-optical Q-switched lasers with CW pumping. On the other hand a short rising (falling) time allows operation in short-pulsed systems with high peak output power and energy (flashlamp pumped Nd:YAG lasers).

Another advantage of STQBD-series drivers is an ability of handling with extremely high loads (up to 0.5 nF). This feature leads to higher reliability of the device and permits remote operation of Pockels cell in laser head that can be connected to driver using long cables (correct and effective operation has been approved with cables up to 3 meters). This allows the designing of Q-switched laser systems with compact remote laser heads where close placement of Pockels cell and driver is impossible because of volume insufficiency or other causes.

Features

- Extremely flexible solution
- Pull-up and pull-down schemes
- Up to 5 kV output voltage
- Up to 0.5 nF load
- Compact OEM design
- Long cable operation
- Up to 100 kHz repetition rate

Specifications

Input:	
Voltage	+24VDC
Output:	
Voltage	up to 5 kV
Repetition Rate	from single pulse to 100
Load	up to 0.5 nF
Rise time / Fall time	20 ns
Safety:	
Leakage Current	not more than 150 uA
Environment:	
Operation Temperature	-20...+45 C
Storage Temperature	-40...+85 C
Humidity	90%, non-condensing
Size (LxWxH)	130x80x20 mm
Weight	0.1 kg
Options	Harsh environment version



Part Number Description:

STQBU-XXYY

STQBU – STQBU series EO Q-switch driver

XX – maximum output voltage from 20 to 60 (2 - 6kV)

YY – minimum output voltage from 12 to 20 (1.2 – 2.0kV)

We offer four standard solutions:

- STQBU-6024
- STQBU-5020
- STQBU-4016
- STQBU-3012
- STQBU-2008

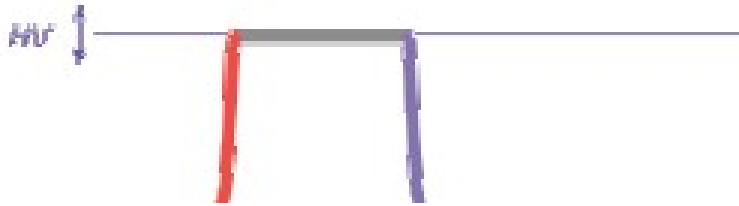

Options

Adjustment range of output voltage (see figure) can be selected within the following model series: STQBU-5020 (2-5 kV), STQBU-4016 (1.6-4 kV), STQBU-3012 (1.2-3 kV), STQBU-2008 (0.8-2 kV). Time of rapid pulse growth (20 ns) is indicated red on figure time of same rapid slump is indicated blue (20 ns). Adjustable voltage level is designated by the arrow.

Application

STQBU-Series Pockels Cell Drivers are available in standard and special versions. Standard modification is a relatively simple OEM device designated for operation in laboratory or medical laser systems at normal temperature and humidity conditions. These modules are designed in accordance with IEC60601-1 medical safety standard requirements. Output parameters (direct high voltage) are controlled by use of analog interface.

Special version is available for laser systems designated for operation in harsh environment. These devices are distinguished due to wide operation temperature range, humidity and vibration steadiness. In this version all parameters are controlled by simple and reliable internal multi-turn trimpots.

Working Scheme

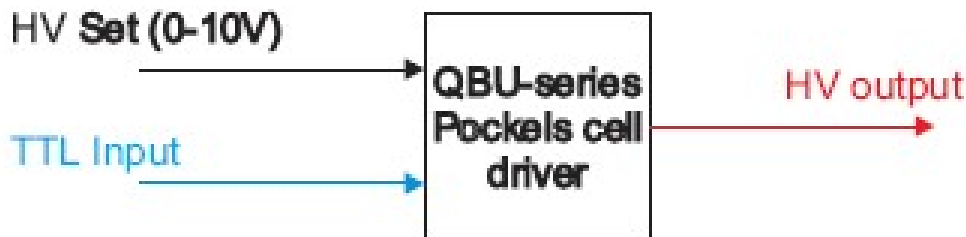

TTL input of almost arbitrary shape



11. STQBU-BT Series EO Q-switch Drivers

STQBU-BT-series consist of five Pockels cell drivers differ with their output voltage range and covering range up to 6.0 kV. High repetition rates and fast transition times are additional benefits.

Modules allow operations in three different modes (pull down scheme (= normally on), push up scheme (= normally off) and external synchronization mode (= repetition of external low voltage signal)) and therefore suit ideally for the laboratory usage.

Features

- Extremely flexible solution
- Push-up and pull-down schemes
- Up to 6 kV output voltage
- Up to 50 kHz (CW) repetition rate
- Pulses width from 1us to DC
- 20 ns rise/fall times
- RS-232 interface



Specifications:

Input:	
Voltage	110/230 VAC; 50/60 Hz
Current	1 A max

Output:	
Working modes	Pull-down scheme, push-up scheme, repetition of external signal
Voltage, high level	regulated, up to 6 kV
Voltage, low level	fixed, 0 V
Pulse width	1 us - DC
Repetition rate	up to 50 kHz (CW), up to 100 kHz (burst-mode)
Rise time	< 20 ns
Fall time	< 20 ns
Jitter	10 ns (1 ns in LJ-modification)
Delay time	1 us (100 ns in LJ-modification)
Load capacitance	up to 0.5 nF
Environment:	
Operation temperature	0 ... +40 °C
Storage temperature	-20 ... +60 °C
Humidity	90 %, non-condensing
Size (LxWxH)	225x200x60 mm
Weight	2 kg



Performance

For STQBU-BT-5020 continuously operated in internal synchronization mode we warrant the performance table as follows:

11 pF load capacitance							
Voltage, kV	2.0	2.5	3.0	3.5	4.0	4.5	5.0
Max. rep. rate, kHz	56	40	31	24	18	15	12
23 pF load capacitance							
Voltage, kV	2.0	2.5	3.0	3.5	4.0	4.5	5.0
Max. rep. rate, kHz	45	32	24	18	14	12	9

External synchronization mode shows usually a little higher performance.

In the burst-mode (= short time operations) performance is increasing approximately twice and may achieve 100 kHz value at low operating voltages and load capacitance.

High load capacitance decreases the performance.

Part Number Description:

STQBU-BT-XXYY

STQBU-BT – STQBU-BT series EO Q-switch driver

XX – maximum output voltage from 20 to 60 (2 - 6kV)

YY – minimum output voltage from 12 to 20 (1.2 – 2.0kV)

We offer five standard solutions:

STQBU-BT-6024

STQBU-BT-5020

STQBU-BT-4016

STQBU-BT-3012

STQBU-BT-2008



Options

Adjustment range of output voltage can be selected within the following model series: STQBU-BT-6024 (2.4-6 kV), STQBU-BT-5020 (2-5 kV), STQBU-BT-4016 (1.6-4 kV), STQBU-BT-3012 (1.2-3 kV), STQBU-BT-2008 (0.8- 2 kV).

12. STQBX-08 Series Arbitrary Waveform Pockels Cell Drivers

APPLICATIONS

- Beam deflection and steering
- Beam intensity control
- Non-optical: PLZ, MEMS etc

FEATURES

- Output voltage – up to 800V
- Fast rise and fall times – <1us
- Repetition rate – up to 1MHz (load and voltage dependent)
- PCB and enclosed versions



STQBX-08 is a dedicated Pockels cell drivers designed for applications where voltage on the Pockels cell should be continuously adjustable. Driver is built on voltage amplifier schematics, maximal output voltage is 800V (other voltages both smaller and higher up to 1600V are available on request), amplification factor is 100:1. Driver is forced air cooled with embedded fan. Driver can be supplied in PCB and enclosed versions.

Input	
Power	24VDC, 1.5A typ.
Signal	Analogue signal 0-8V, input impedance 50Ohm
HV output	
Output type	High voltage signal repeating the shape of low voltage input signal
Output polarity	Positive
Amplitude	0-800V (100:1 amplification)
Repetition rate	Up to 1MHz (at smaller loads and voltages); also limited as $f_{MAX} * C * U^2 = 2W$, for example: ~50kHz @ 800V and 60pF, ~130kHz @ 500V and 60pF
Rise/fall time (full slope)	<1us (1 microsecond)
Delay time	<1us
Load requirements	
Load type	Capacitive (other on request)
Load capacitance	<60pF (other on request)
Cooling	Forced air cooling with embedded fan
Environmental	
Operating temperature	+10...+40C
Mechanical	
Dimensions	206x85x30mm
Weight	Approx. 0.6kg

INTERFACES

	TYPE	DESIGNATION	DESCRIPTION
X1	CONNECTOR	INPUT	Analogue input signal
J1	CONNECTOR	HV OUTPUT	HV output (amplified input signal)
J2	CONNECTOR	24VDC/INTERFACE	DC power to the module, controls to the module (enable, fault etc)
B1	SWITCH	ENABLE SWITCH	Enables the output

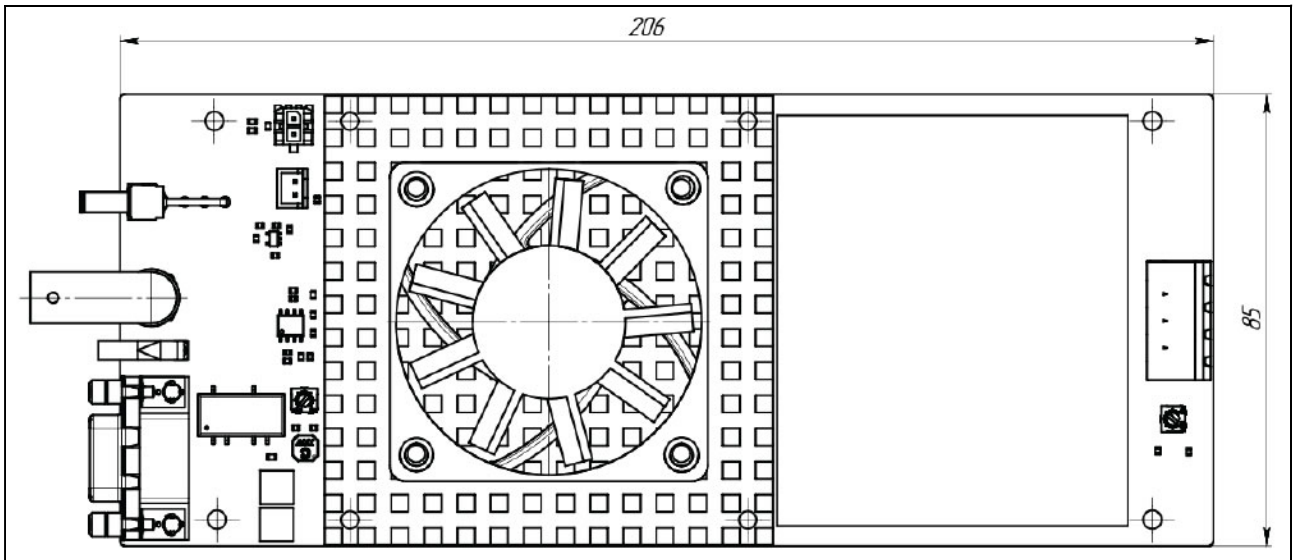
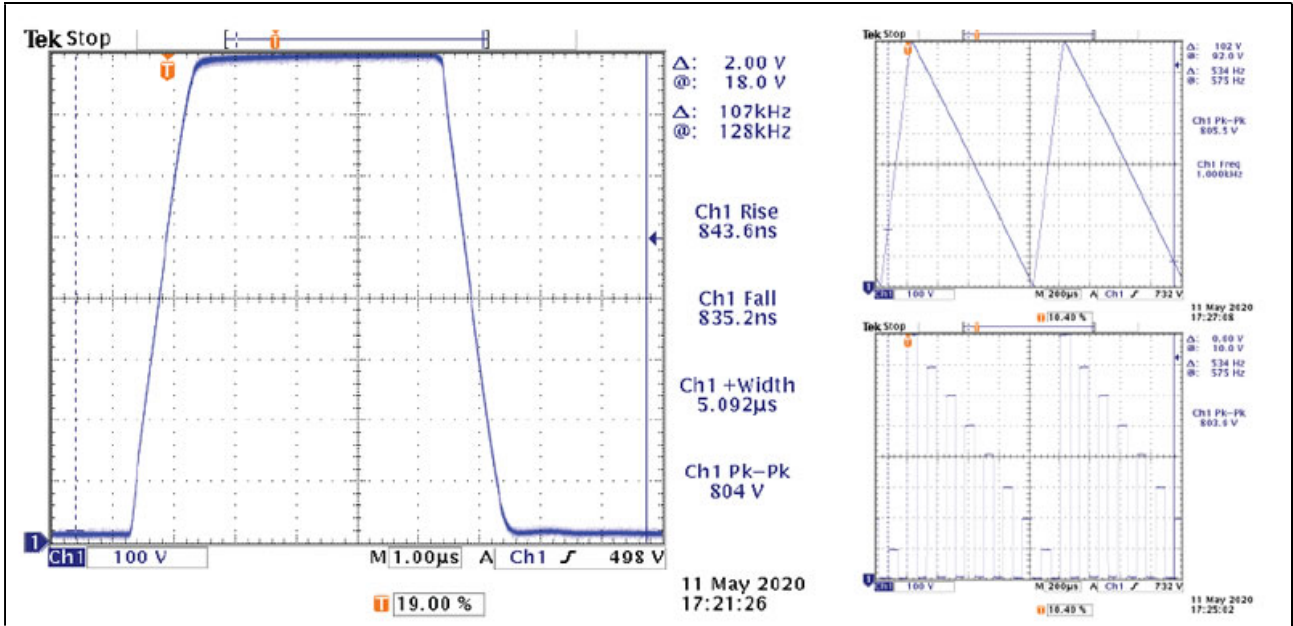

Pockels Cell (EO Q-switch) Questionnaire

If you would like us to make a Pockels cell recommendation, we would like to know the following information about your application:

- Information needed for any Pockels cell inquiry

1 What is the application of this pockels cell (Q-switch, regenerative amplifier, pulse picker or other)?

Ans :

2 What is the beam diameter or radius (1/e² value)? Please specify as Radius or Diameter.

Ans :

3 What is the beam profile (Gaussian, Pseudo-Gaussian, Top-hat, etc)?

Ans :

4 What is the wavelength of operation (nm)?

Ans :

5 What is the laser repetition rate?

Ans :

6 What is the laser peak power (extra-cavity)?

Ans :

7 What is the energy-per-pulse?

Ans :

8 What is the pulse width (FWHM)?

Ans :

9 Will you use the cell in quarter-wave or half-wave operation?

Ans :

10 What is the cell repetition rate and voltage pulse duration that you intend to use?

Ans :

11 What is your duty cycle?

Ans :

12 What is the operating environment at the cell (temp, atmosphere, humidity)?

Ans :

13 If using a laser cavity, what is the finesse or output coupler reflectivity?

Ans :

14 Do you intend to use a bias or constant on voltage, switching to ground? (This is not typically recommended and may cause short cell life)

Ans :

15 What quantity do you require?

Ans :

1. How to Select an EO Q-switch to Meet Your Switching Frequency Requirement

The simple answer is that the STG-IMPACT Pockels cells are recommended for operation at a maximum of 1-2kHz. This is not to say they will completely fail to operate at 5kHz. The contrast ratio will be sacrificed as the repetition rate is increased beyond 1kHz. The reason for this is contained within the nature of the DKDP crystal, When high voltage is applied, the crystal lattice is distorted, causing the desired Pockels effect. However, the longer that the voltage is applied, either in terms of electric pulse duration or in the repetition rate used, the distortion causes an acoustic resonance to develop. This is commonly referred to as "ringing" in the crystal. This is true of any cell that uses KDP/DKDP as its crystal element. To illustrate this point, the following figures show several optical traces of the acoustic ringing

from an STG-IMPACT 8 Pockels cell when operated at 1kHz repetition rate. One trace (time stamp 8:26:43) allows the vertical (y-axis) to autoscale to a maximum of the signal from the electrical pulse. In the second trace (time stamp 8:25:14), we have collapsed the y-axis so that you don't see the maximum of the electrical pulse. Although the collapsed y-axis truncates the initial pulse maximum, it increases the visual appearance of the acoustic ringing following the initial pulse. In either case, you can see the acoustic ringing subsides after about 1millisec.

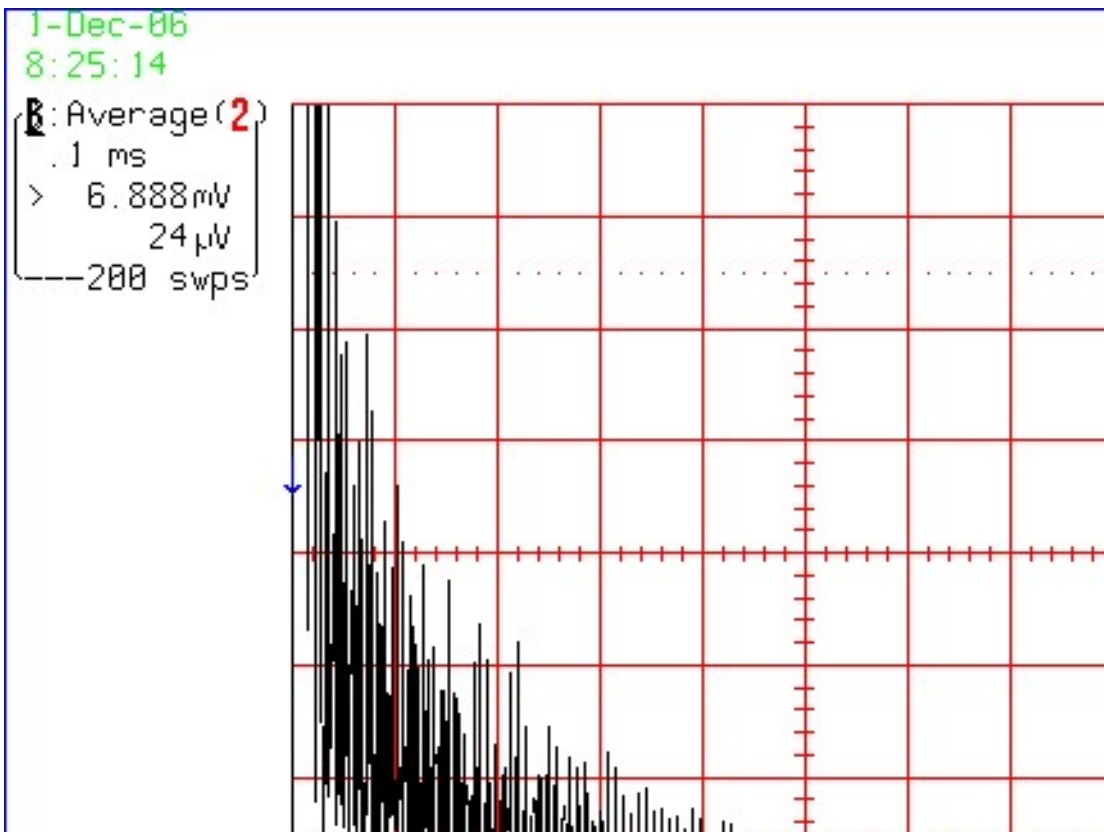
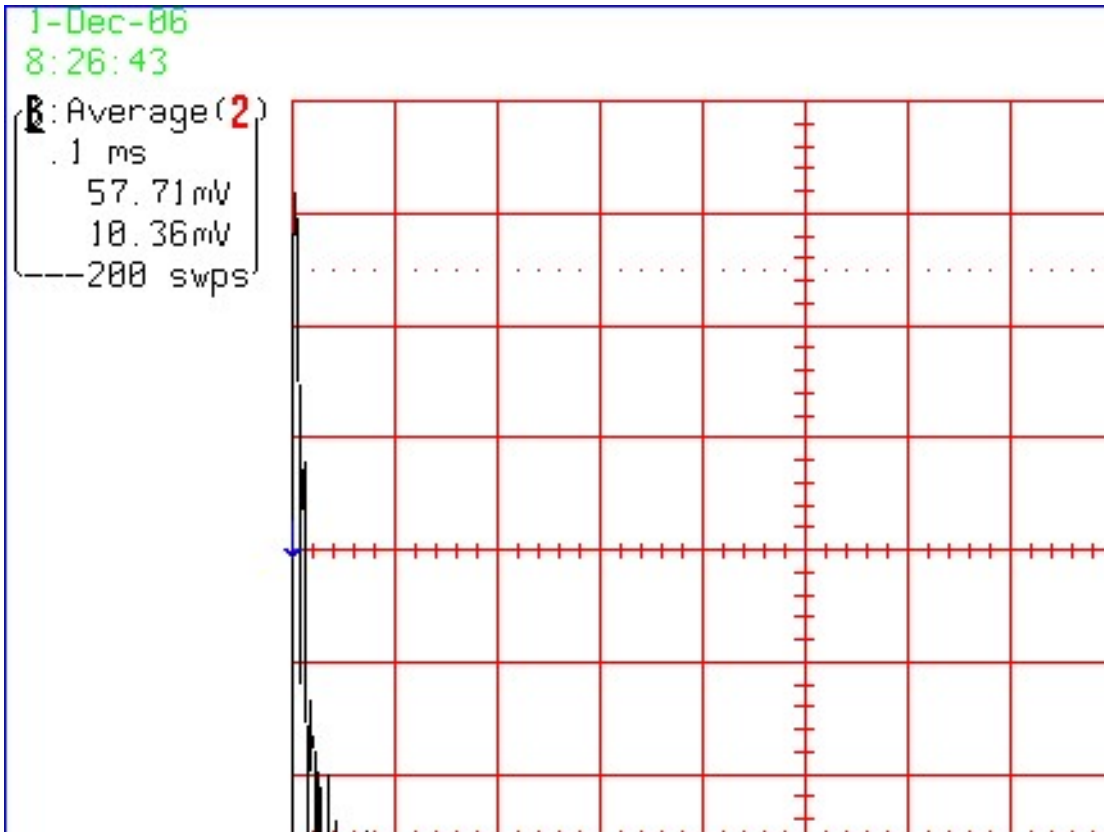

Although we generally recommend STG-QX series Pockels cells for applications at >2kHz, whether or not the STG-IMPACT 8 will work depends upon how much loss of contrast ratio their system can

tolerate. But if you want a cut and dry answer, I'd recommend against operation at 5kHz. The STG-QX and STG-IMPACT cells use the same high quality DKDP crystal in similar sizes. The significant difference is the construction of the cell housing. The STG-QX cell design is such that it provides some suppression of this ringing out to about 5kHz normally and is available in a damped version which will suppress this condition to <10kHz.

The BBO cell will operate into the 500kHz region and higher.

2. How to Select Aperture

In a Gaussian beam there will be ~10% of the laser energy present at a diameter of 2-3 times the $1/e^2$ diameter. This will result in a significant loss of energy in the system and this energy can scatter inside of the cell and damage the cell. We would suggest that the aperture of the Q-switch is 2 to 3 times of laser beam diameter ($1/e^2$). If the beam can be modified into something close to a "tophat" profile then the aperture requirement drops substantially.

3. What is maximum allowed laser energy? what is the maximum allowed peak power? What is the maximum peak power beam which can be switched off?

If you have a large, perfect beam you can get much more energy through the cell without damage than if you have a beam with hot spots and caustic retro-reflections, etc. In an 8.5mm beam, "typical" maximum wattages would range from 5-30W but, theoretically, DKDP can be used into the 50-75W region...but EVERYTHING has to be perfect. This is one of those situations where general rules just don't have much use.

4. What is the laser beam pulse width and rise time?

The performance of the cell is directly related to the driver. The cell has a theoretical rise time on the order of 80ps...but the best drivers can only drive a rise time of 2-6ns. Pulse width and fall time are similarly affected. The electronics are fairly simple for a q-switch driver at 1/4 wave and a few Hz. Driver designs get MUCH more complicated for a region or a pulse picker at 10 or 100kHz and 1/2 wave voltage.

5. Do we need a waveplate?

Our cell does not contain a waveplate in it. If the customer's application requires a 1/4 waveplate then he will have to add it into the system himself.

6. How to Select a Driver?

Any driver that produces ~3KV (2.6KV) will operate the cell to 1/4 wave. The driver that we offer at http://www.sintecoptronics.com/qswi_tcheoDriver.htm should work.

7. How to Select Pulse Shape and Duty Cycle?

You can operate the cell with either a pull-up voltage or a pull-down voltage. Changing the polarity will only change the direction of the phase rotation. You should not, however, operate the cell with a constant applied voltage potential between the terminals, or a duty cycle greater than ~ 2%. "Pull-down" usually involves a constant applied or bias voltage. This type of operation is specifically not recommended. We have had customers that use this method to varying degrees of success. This type of operation usually results in dramatically reduced cell lifetimes. We offer no warranty coverage on cells that have been used in this manner.

8. How about Operation Environment?

Our recommended range would be in the 10-30 deg C range. Higher temps will seriously degrade performance. Voltage requirements will change with temperature as well. Also important is the rate of temperature increase. KDP is quite sensitive to thermal shock. KDP cells should never be warmed or cooled at a rate of more than 1-2 deg per hour.

9. How to Place an order for a STG-QX cell?

Fluid filled cells are provided for legacy systems or special applications only. SolGel dry type cells are recommended for optimal performance in most systems. When you place the order for a STG-QX cell, please define window wedge (0 deg or 1 deg) and endcap style (DT, TK, TN).